

UV/VIS SPECTROPHOTOMETER

LLG-uniSPEC 4

USER'S MANUAL



Contents

Safety	2
General	2
Electrical	2
Warning	2
Performance	3
Radio Interference	3
Introduction	3
Working Principle	4
Unpacking Instructions	5
Specifications	5
Installation	6
Operation	6
Prepare the Spectrophotometer	6
Description of keys	7
Turn on spectrophotometer	8
Basic operation.....	9
Analyse Sample	14
Basic Mode	14
Quantitative	15
WL Scan	21
Kinetics	27
DNA/Protein	30
Multi Wavelength	32
Setting and Calibration	34
Utility	34
Instrument Maintenance	46
Daily Maintenance.....	46
Trouble Shooting.....	46
Spare parts Replacement.....	46
Appendix A	51
Appendix B	52

Safety:

The safety statements in this manual comply with the requirements of the HEALTH AND SAFETY AT WORK ACT, 1974.

Read the following before installing and using the instrument and its accessories. This instrument should be operated by appropriate laboratory technicians.

General:

The apparatus described in this manual is designed to be used by properly trained personnel in a suitable equipped laboratory. For the correct and safe use of this apparatus it is essential that laboratory personnel follow generally accepted safe procedures in addition to the safety precautions called for in this manual.

The covers on this instrument may be removed for servicing. However, the inside of the power supply unit is a hazardous area and its cover should not be removed under any circumstances. There are no serviceable components inside this power supply unit. For this instrument, avoid touching the high voltage power supply at all times.

Some of the chemicals used in spectrophotometry are corrosive and/or inflammable and samples may be radioactive, toxic, or potentially infective. Care should be taken to follow the normal laboratory procedures for handling chemicals and samples.

Electrical:

Before switching on the apparatus, make sure it is set to the voltage of the local power supply (see Installation).

The power cord shall be inserted in a socket provided with a protective earth contact. The protective action must not be negated by the use of an extension cord without a protective conductor.

Warning:

Any interruption of the protective conductor inside or outside the apparatus or disconnection of the protective earth terminal is likely to make the apparatus dangerous. Intentional interruption is prohibited.

Whenever it is likely that the protection has been impaired, the apparatus shall be made inoperative and be secured against any unintended operation.

Note: NEVER touch or handle the power supply on this instrument due to the high voltage !

The protection is likely to be impaired if, for example, the apparatus

- Shows visible damage
- Fails to perform the intended measurements
- Has been subjected to prolonged storage under unfavorable conditions

- Has been subjected to severe transport stresses

Performance:

To ensure that the instrument is working within its specification, especially when making measurements of an important nature, carry out performance checks with particular reference to wavelength and absorbance accuracy. Performance checks are detailed in this manual.

Radio Interference:

For compliance with the EMC standards referred to in the EC Declaration of Conformity, it is necessary that only shielded cables supplied by us are used when connecting the instrument to computers and accessories.

Introduction:

This instrument (Fig 1) is a single beam, general purpose instrument designed to meet the needs of the Conventional Laboratory, This instrument is ideal for various applications, such as: Chemistry, Biochemistry, petrochemistry, Environmental Protection, Food and Beverage Labs, Water and Waste Water Labs and other fields of quality control and research.

This instrument incorporates a 320×240 dot matrix LCD display for photometric results, easy operation and wavelength range of 190nm to 1100nm. This instrument is ideal for measurements in the visible and ultraviolet wavelength region of the electromagnetic spectrum.



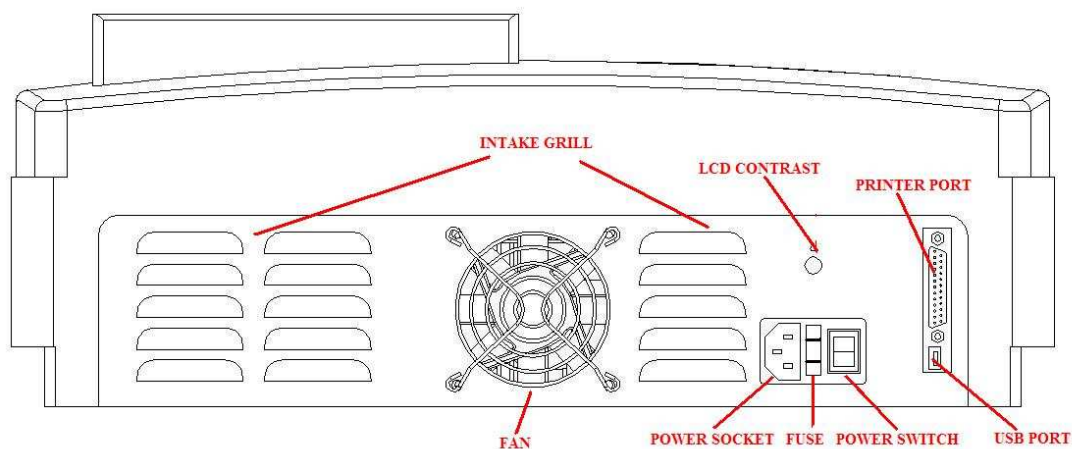

Fig1 Front and Back View of the instrument

Working Principle:

The spectrophotometer consists of five parts: 1) Halogen or deuterium lamps to supply the light; 2) A Monochromator to isolate the wavelength of interest and eliminate the unwanted second order radiation; 3) A sample compartment to accommodate the sample solution; 4) One detectors to receive the transmitted light and convert it to an electrical signal; 5) A digital display to indicate absorbance or transmittance. The block diagram (Fig 2) below illustrates the relationship between these parts.

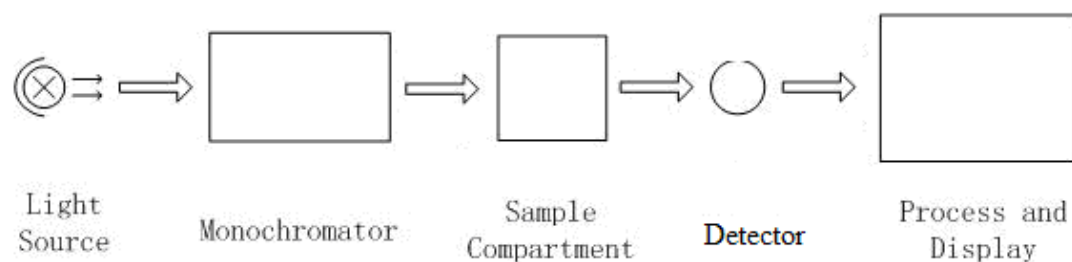

Fig 2

In your spectrophotometer, light from the lamp is focused on the entrance slit of the monochromator where the collimating mirror directs the beam onto the grating. The grating disperses the light beam to produce the spectrum, a portion of which is focused on the exit slit of the monochromator by a collimating mirror. From here the beam is passed to a sample compartment through one of the filters, which helps to eliminate unwanted second order radiation from the diffraction grating. Upon leaving the sample compartment, the beam is passed to the silicon photodiode detector and causes the detector to produce an electrical signal that is displayed on the digital display.

Unpacking Instructions:

Carefully unpack the contents and check the materials against the following packing list to ensure that you have received everything in good condition.

Packing List

<u>Description</u>	<u>Quantity</u>
• Spectrophotometer.....	1
• Mains Lead.....	1
• 10mm Glass Cuvettes.....	1 Set of 4
• 10mm Quartz Cuvettes.....	1 Set of 2
• User's Manual.....	1
• Dust Cover.....	1
• Software Manual.....	1
• Software Kit (Disc 1+ USB Lead 1+ Dongle 1).....	1

Note: The printer and auto-cell holder mentioned in this manual are all optional accessories, they do not come standard with the instrument.

Specifications:

• Wavelength Range:	190-1100nm
• Spectral Bandpass:	1.0nm
• Wavelength Accuracy:	$\pm 0.3\text{nm}$
• Wavelength Repeatability:	0.2nm
• Baseline Flatness:	$\pm 0.001\text{A}$
• Stray Light :	0.05% @ 220nm & 360nm
• Photometric Range:	0-200%T, -0.3-3.0A
• Noise:	0.001A @ 500nm
• Drift:	< 0.002A/h @ 500nm
• Power Requirements:	AC 110V/60Hz or 220V/50Hz
• Dimensions(mm)	625L \times 430L \times 206H
• Light Source:	Tungsten Halogen/Deuterium
• Net Weight:	28kg

Installation:

1. After carefully unpacking the contents, check the materials with the packing list (page 4) to ensure that you have received everything in good condition.
2. Place the instrument in a suitable location away from direct sunlight. In order to have the best performance from your instrument, keep it as far as possible from any strong magnetic or electrical fields or any electrical device that may generate high-frequency fields. Set the unit up in an area that is free of dust, corrosive gases and strong vibrations.
3. Remove any obstructions or materials that could hinder the flow of air under and around the instrument.
4. Use the appropriate power cord and plug into a grounded outlet.

5. Turn on your spectrophotometer. Allow it to warm up for 15 minutes before taking any readings. We suggest you then do the Calibrate System with the Search 656.1nm to set the wavelength to the deuterium lamp emission line.

NOTE:



This symbol means Caution, Risk of Danger.

Operation:

Prepare the spectrophotometer

Fig 3 is the control panel. User can perform all operations by pressing the keys and all the results and operation information are displayed on the LCD.

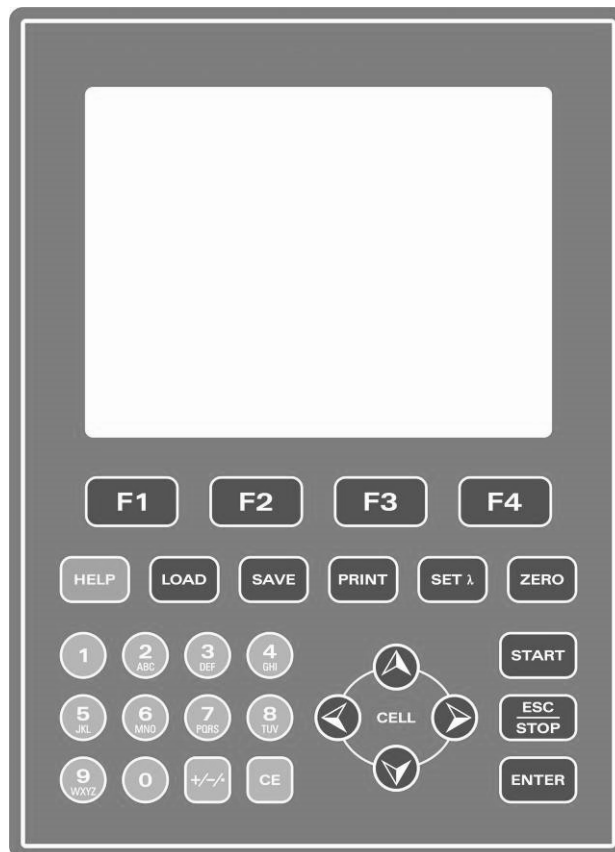

Fig 3

- **Description of keys**

- | | |
|----------------|-----------------------------------|
| 【LOAD】 | Load data or curve saved before; |
| 【SAVE】 | Save data or curve; |
| 【SET λ】 | Set wavelength; |
| 【ZERO】 | Blank or scan the user base line; |
| 【PRINT】 | Print test results or screen |
| 【START】 | Start testing or scanning sample; |

【ESC/STOP】	Exit to previous screen or cancel the operation;
【ENTER】	Confirm the inputted data or selected item; Go into next setup or screen;
【F1】 – 【F4】	Function based on the information on the screen;
【0】 – 【9】	Input number or letter, consecutively press a numeric key to select a character;
【+/-/.】	Input +,- or dot;
【CE】	Clear all characters when you are inputting or clear curve displays on the screen;
【<】 , 【>】	Change “x” scale; Search point after scan; 【<】 clear a character;
【^】 , 【v】	Change “y” scale; Search peak after scan; Scroll items for selecting; Change capital/small letter last typed in; Browse the items for selection;
【CELL】	Set cell position (Only available when Auto Changer used).
【HELP】	Reserved key for future Function Extending, not available now.

- **Turn on spectrophotometer**

Turn on spectrophotometer by pressing the Power Switch (IO)(see Fig1).

Note: If you find the screen is not bright enough, you can adjust the brightness by turning the knob of the screen adjuster which located in the back of the instrument.(Fig.1)

The instrument starts to initiate and the steps are as below:

1. The instrument will check memory first (Fig 4), please wait or press any key to skip this step ,after positioning filter, auto-cell changer(if installed) and D2/W lamps, the screen display as Fig 4A. 15 minutes pass or press **【ESC】** , the screen display as Fig 5,Select “No” to skip to main menu(Fig 7) and select “Yes”(recommended) to calibrate system (Fig 6).The calibrating process include “get dark current”, “searching 656.1nm” and “check energy”. After finish the calibration system, go to main menu too (Fig 7).

2. If the data in memory has been lost, the instrument will directly calibrate system without any choice for you.

3. If no auto-cell changer installed “cell #1” will disappear in Fig7

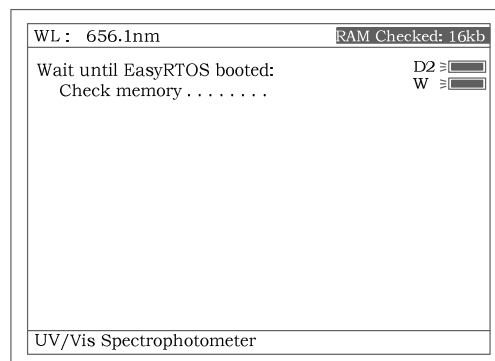

Fig 4

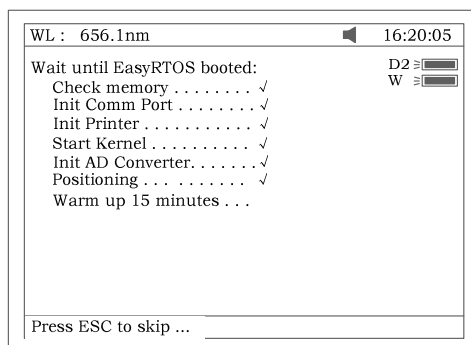

Fig 4A

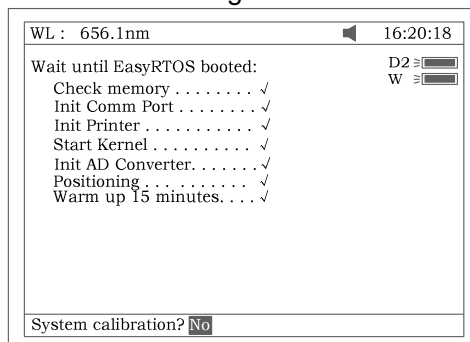

Fig 5

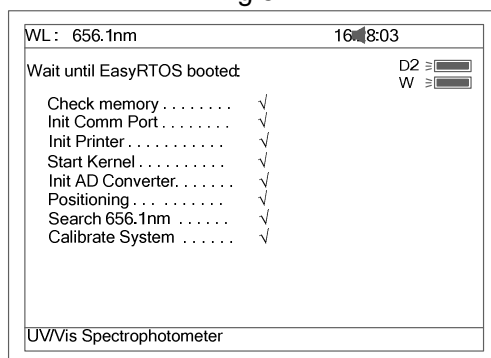

Fig 6

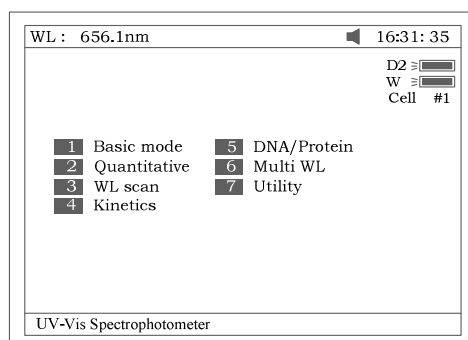

Fig 7

- **Basic operation**

- **※ Blank**

There is a system baseline stored in the memory of the instrument. Usually user may not rebuild system baseline before test. As the system baseline always get a little change after the instrument is powered on, it is necessary for

the user to rebuild the system baseline. There are a couple of ways to rebuild the system baseline. Select “Yes” in Fig 5 or Press **【0】** In Fig 73 or Press **【F4】** In Fig41,

Regarding Blanking, important points list below:

A. Take measure in Basic Mode

- a. Put the reference cuvette with *reference solution* into the Light Path and press the key **【ZERO】** for blanking.

Note 1. If the reference solution is too thick, “Energy Low...” will appear following the “Blanking...” on the screen (Fig 8). If “Energy too Low...” appears following the “Blanking...”, the test will be paused and “Warning...” will appear on the screen. (Fig 9).

2. If no automatic changer installed “cell #1” and “Max E” will disappear in Fig8

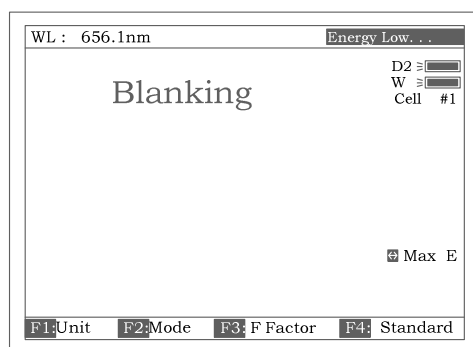

Fig 8

3. **DO NOT OPEN SAMPLE COMPARTMENT LID DURING BLANKING.**
4. The dark current don't be taken after power on if you bypass the calibrating system. It is recommended to take the dark current after warm up. (See page 38).



Fig 9

b. Take out the sample cuvette, replace the *reference solution* with *sample solution* after flushing the cuvette completely. Put the sample cuvette into the Sample Light Path, then the result will display on the screen

automatically. However the **【START】** must be pressed in other measurements such as DNA/Protein, Muli WL and Quantitative etc.

B. Take measure in WL Scan

After all scan parameters are entered, put the reference cuvette with *reference solution* into the Light Path, Press **【ZERO】** to obtain the user baseline. Then put the sample cuvette into the Light Path. Press **【START】** to scan.

※ **Set wavelength** (Example: set wavelength in “Basic mode”)

◇ Press **【SET λ】** (Fig 10).

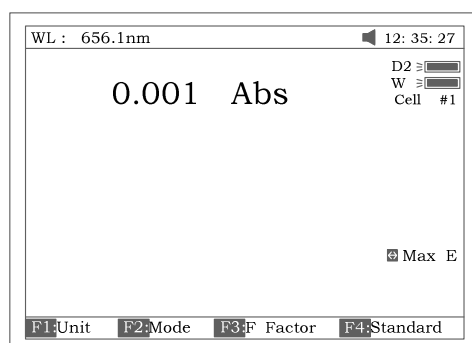

Fig 10

◇ Use numeric keypad to input wavelength (Fig 11).

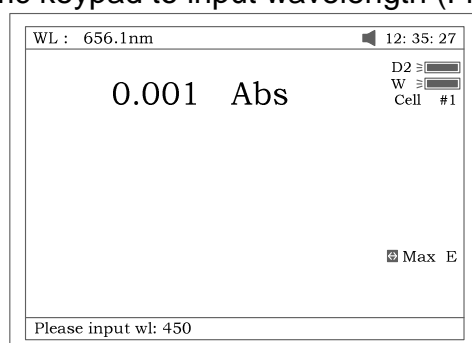

Fig 11

◇ Press **【ENTER】** to change the wavelength from 656.1nm to 450.0nm, and then blank; After blanking, the screen displays as Fig 12.

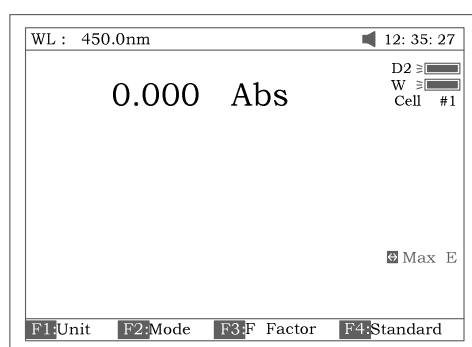

Fig 12

※ **Load or delete data or curve** (Take the “WL scan” test For example)

Press **【3】** in Fig.7 go into “WL scan”. After **【LOAD】** being pressed, the first file (ABC.wav)in memory will appear on the bottom line of screen .Showed as Fig 13. Press **【^】** or **【v】** to browse the files stroed in memory. Then if :

1. The key **【ENTER】** be pressed, the file selected will be loaded and displays on the screen. Fig 14.

Note (1) The file selected must match “WL scan” test’s type. If not, the “file type error...” will appear on the Right of top line.

(2) Different test has different file type. Refer to table 1 on Page 12.

2. The key **【CE】** be pressed, the file selected will be deleted by selecting “Yes”.

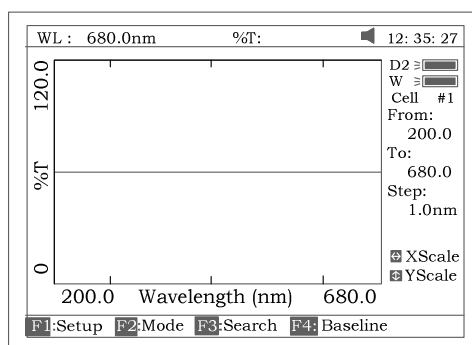

Fig 13

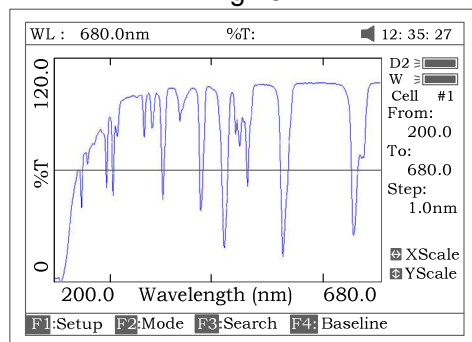

Fig 14

Table 1

Test	File Type
Quantitative Curve	***.fit
Quantitative Test Result	***.qua
WL Scan	***.wav
Kinetics	***.kin
DNA/Protein	***.dna
Multi WL	***.mul
WL Validity	***.wlv
Accu. Validity	***.phv

※ **Save data or curve** (Example: Save curve in “WL scan”)

◇ Press the key **【SAVE】** in Fig14 to save curve.

✧ Name the curve by pressing the numeric keypad (Fig 15), press the key **【ENTER】** to confirm.

- . **Note(1)**. Pressing numeric key continually to scroll characters and pressing **【^】**, **【v】** to alter capital letter to miniscule. Table 2 shows all characters built in.
- (2)** If the name already exists in memory, the warning “duplicated name, are you sure?” will appear. “Yes” for overwrite and “No” for Exit.
- (3)** The length of filename is less than 4.

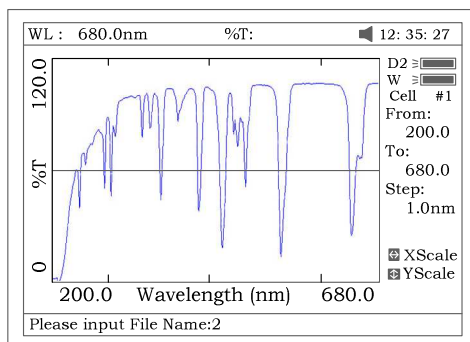

Fig 15

Table 2

key	representing	key	representing	key	representing
0	0,+,-,*,/,	1	1,#,?,;,	2	2,A,B,C,=
3	3,D,E,F,%	4	4,G,H,I,{	5	5,J,K,L,}
6	6,M,N,O,~	7	7,P,Q,R,S,	8	8,T,U,V,“
9	9,W,X,Y,Z	+/-.	-,.,		

※ **Print test report** (For example: Print the report in “Basic mode”, Fig16)

Press the key **【PRINT】** to print the report (curve or data you have loaded or tested, Fig 17).

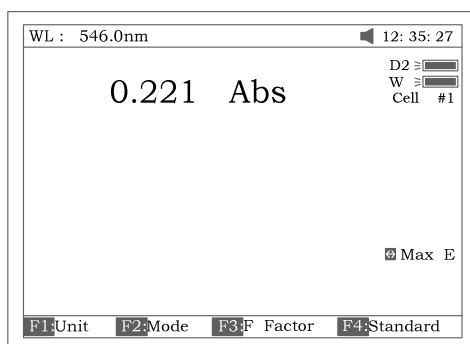

Fig 16

Basic Mode Test Report

Wavelength: 546.0nm
Result: 0.221 Abs
Date and Time: 25-06-2003 13:55:53

Fig 17

Before measurement

- Make a blank reference solution by filling a clean cuvette (or test tube) half full with distilled or de-ionized water or other specified solvent. Wipe the cuvette with tissue to remove the fingerprints and droplets of liquid.

Analyze Sample

For different user's requirements, we provide different test methods.

Basic Mode

Push the blank cuvette into the Light Path, In main menu (Fig7), press **【1】** to enter "Basic mode" test. After automatically blanking, it will display as Fig 18 (automatic changer installed) or Fig 19 (automatic changer uninstalled) and wait for the operator. **【ESC/STOP】** to exit.

Note: If no automatic changer installed "cell #1" and "Max E" will disappear in Fig18

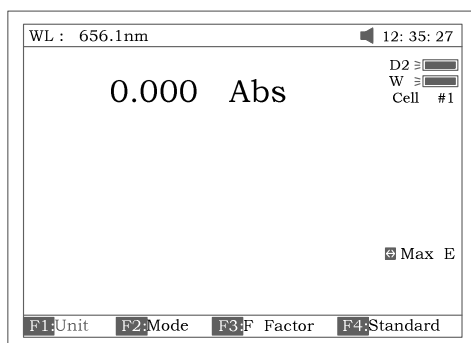

Fig18

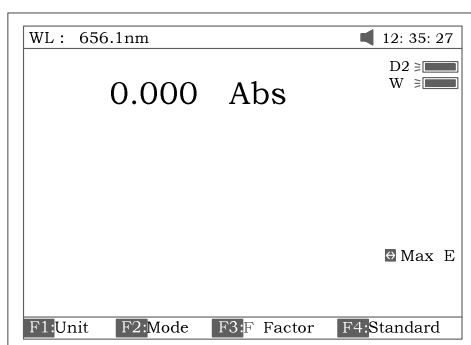

Fig19

☺ Test

There are three modes (T%, Abs, conc/factor) for you to select by pressing **【F2】** to make choice.

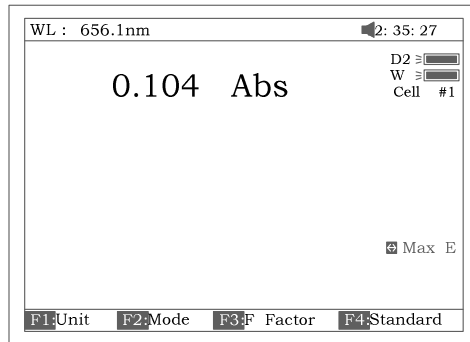

Fig 20

1. Abs mode

Push the blank cuvette into the Light Path. Press **【F2】** to select Abs mode, Press **【ZERO】** for Blanking, and then Push the sample into Main Light Path to take reading (Fig 20)

2. T% mode

The operation is the same as Abs test mode but pressing **【F2】** to select T% mode.

3. Conc/Factor mode

Press **【F1】** to select a concentration unit (Fig 21). If no unit is suitable for your test, please select the item "Other", press **【ENTER】** and input a new unit by pressing the numeric keypad (Fig 22).

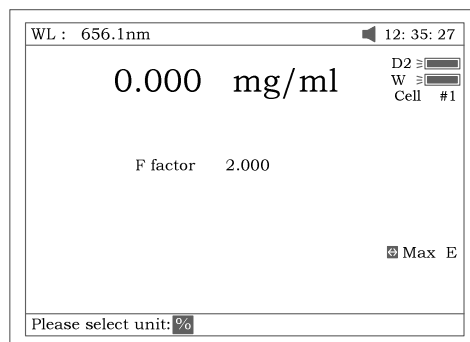

Fig 21

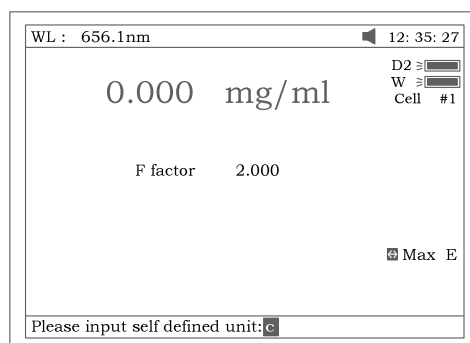

Fig 22

4. Push the blank cuvette into the Light Path and press **【ZERO】** for Blanking. There are now two choices for you to take:
 - 4.1 Press **【F3】** to input known F value, Fig 23. Then push the sample into

- Main Light Path to take reading of concentration
- 4.2 Push sample of known concentration into the Main Light Path
 Press **【F4】** to input known Conc value, Fig 24. Then push the sample into Main Light Path to take reading of concentration.

*Note: 1. You can select wavelength at any time by pressing **【SET λ】**. After your selection, instrument always blanks automatically.
 2. If F value is more than 9999, the clue of “out of range” will display on screen.*

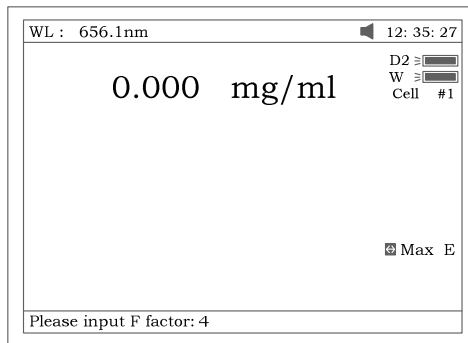

Fig 23

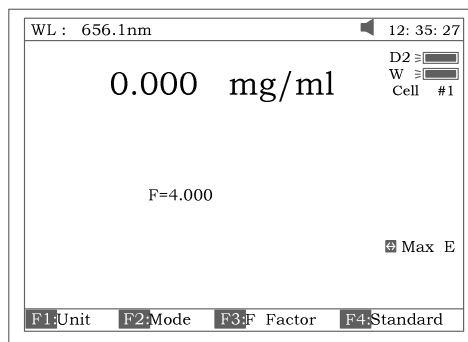

Fig 24

☺ **Print Test Report**

Press **【PRINT】** to print test results (Fig 25).

Basic Mode Test Report

Wavelength: 546.0nm
 Result: 0.221 Abs
 Date and Time: 25-06-2003 13:55:53

Fig 25

Quantitative

Press **【2】** in Main Menu for “Quantitative” Test (Fig 26). Press **【ESC/STOP】** to exit.

Note: .If no automatic changer installed “cell #1” will disappear in Fig26.

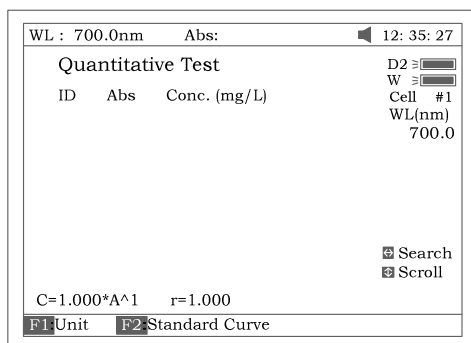

Fig 26

☺ **How to operate**

1. Press **【F1】** to select unit of concentration (Fig 27).

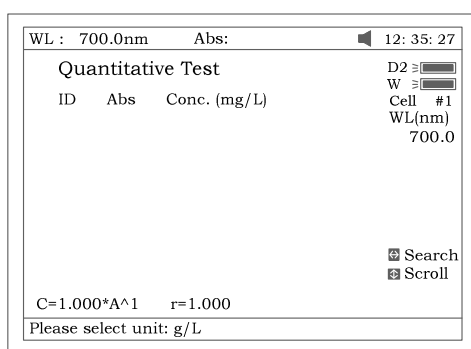

Fig 27

2. Press **【SET λ】** to select correction methods and enter the wavelength. There are three correction methods (single, Isoabsorbance and 3 point, Fig 28)

Note: Please refer to the Appendix B for the correction method.

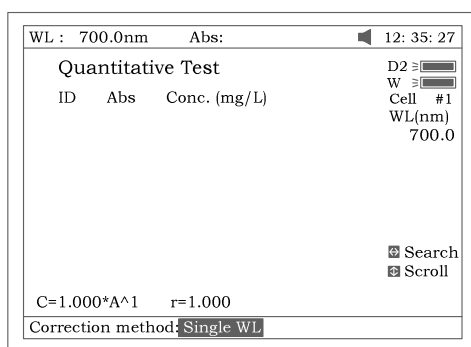

Fig 28

3. Press **【F2】** in Fig 26 for more items to select .See Fig 29.

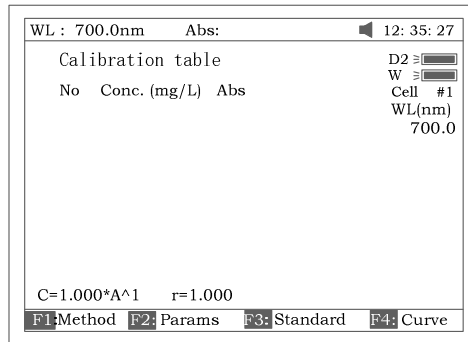

Fig 29

3.1 Press **【F1】** in Fig 29 to select fitting method. There are 4 methods for you to choose: Linear fit, linear fit through zero, square fit and cubic fit.

3.2 Press **【F2】** in Fig 29 to enter directly a known standard curve. Fig 29A.

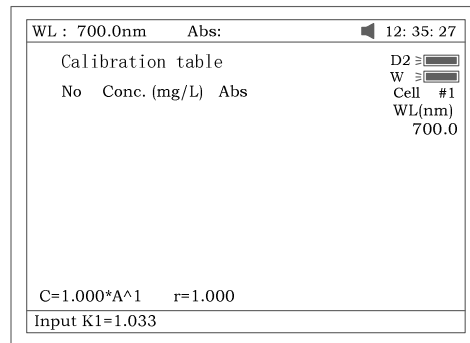

Fig 29A

The constants to be entered depend on which fitting method selected. The table below lists their relation:

Fitting Method	Fitting Equation	constants
linear fit through zero	$C=K1 \times A$	$K1, r^*$
Linear fit	$C=K0+K1 \times A$	$K0, K1, r^*$
square fit	$C=K0+K1 \times A+K2 \times A^2$	$K0, K1, K2$
cubic fit	$C=K0+K1 \times A+K2 \times A^2+K3 \times A^3$	$K0, K1, K2, K3$

* r : regression co-efficients, default=1

3.3 Press **【F3】** in Fig 29 to establish a standard curve by measuring a group of standard samples. See Fig 30.

- 3.3.1 Enter standard concentrations of samples by pressing the Numeric keypad followed by **【ENTER】**. Press **【^】** or **【v】** to modify the inputted data (Fig31). Press **【ESC/STOP】** to finish inputting and to exit (Fig 32).

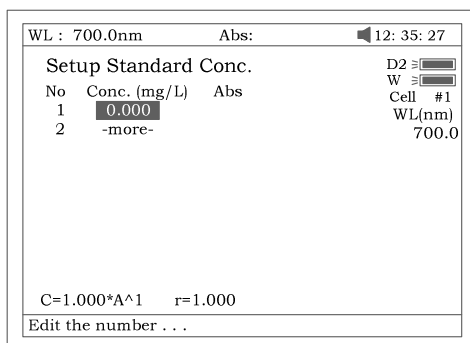

Fig 30

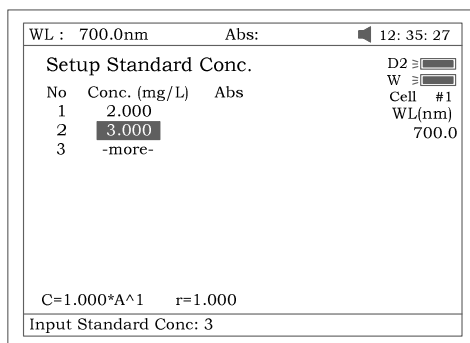

Fig 31

- 3.3.2** Push the blank cuvette into the Light Path, press **【0Abs/%100T】**, the instrument will step to the wavelength and blank. See Fig 32.

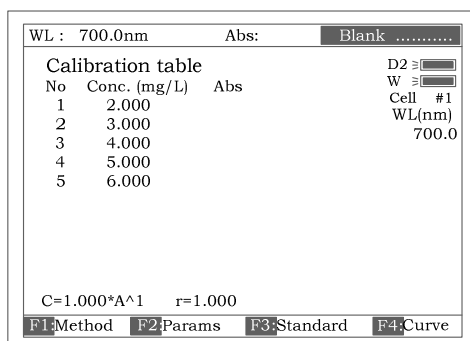

Fig 32

- 3.3.3** Pull the first sample cuvette of known concentration into the light path, Press the key **【START】** to get values of standard curve one by one (Fig 33).
- 3.3.4** Press **【F4】** to draw the curve. You can get a different curve by pressing **【F1】** to select a different fitting method. (See Fig 34-Fig37.) For linear fits, “ r ” represent fitting coefficient of linear regression .r=1 is best fitting.usually “ r ” is very close to 1.

Note:If there are few standard samples, it is not suitable for selecting square fitting, especially cubic fitting, otherwise invalid fitting result will be obtained.

WL: 656.1nm Abs: 12: 35: 27

Calibration table

No	Conc. (mg/L)	Abs
1	2.000	0.247
2	3.000	0.375
3	4.000	0.532
4	5.000	0.603
5	6.000	0.764

D2 ≡
W ≡
Cell #1
WL(nm) 700.0

C=1.000*A^1 r=1.000

F1:Method F2:Params F3:Standard F4:Curve

Fig 33

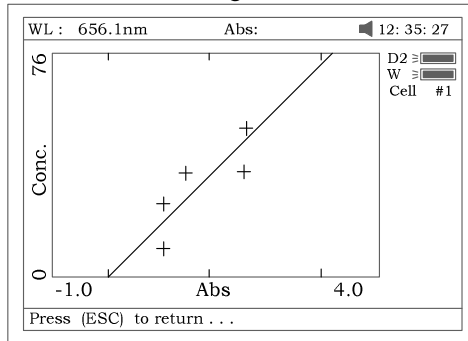

Fig 34 linear through zero fit

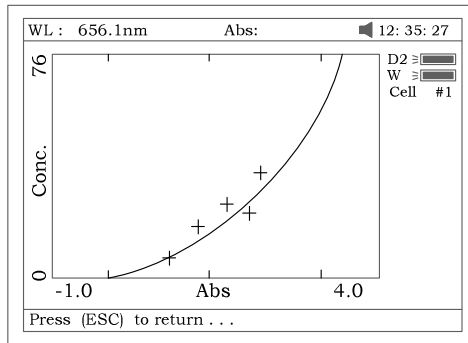

Fig 35 square fit

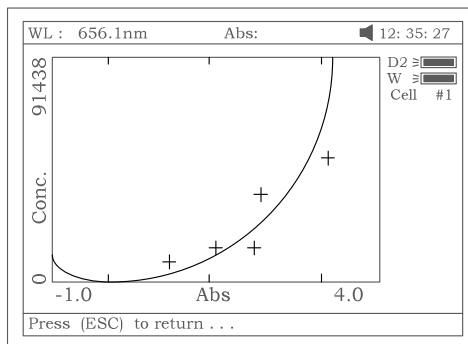

Fig 36 cubic fit

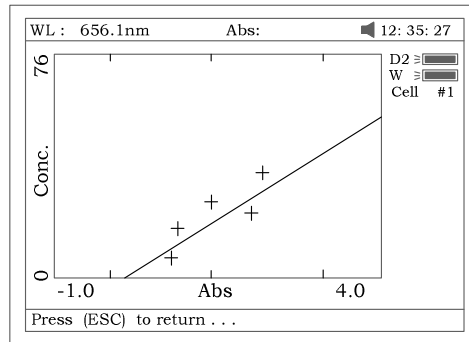

Fig 37 linear fit

3.3.5 Press **【SAVE】** to save calibration if required

3.3.6 Press **【ESC/STOP】** to exit

4. Quantitative Test

Before test, the standard curve must be obtained. There are three ways for you to obtain it (a, b or c).

- Standard curve built up and saved in the instrument.
In Fig 33 press **【Load】** and then press **【^】** or **【v】** to select the file with type *****.fit**. At last press **【ENTER】** TO confirm.
- Known standard curve, which is not saved in the instrument.
See 3.2. For Fig 29 enter a known standard curve directly.
- Use the standard samples for the test. First the standard curve must be established using the method shown in 3.3.

Note: All sample results must be taken in screen Fig26.

4.1 Push the blank cuvette into the Light Path and press **【ZERO】** for blanking.

4.2 Pull the sample cuvette into Main Light Path, press the key **【START】**, the results will be displayed on the screen (Fig 38).

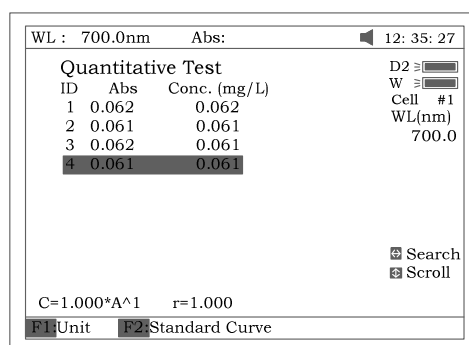

Fig 38

4.3 If there is more than one sample, repeat step 4.2 for the next sample

4.4 Press **(SAVE)** to save the results and fitting parameters

☺ Print Test Report

Press the key **【PRINT】** to print the test report (Fig 39).

Quantitative Test Report

File Name:

Date and Time: 25-06-2003 13:54:32

No	546.0nm	Abs (eff)	C (mg/L)
1	0.212	0.212	3.315
2	0.212	0.212	3.321
3	0.000	0.212	3.315

Fitting Params: $C = 15.64 * A^1$ $r = 0.105$

Fig 40

WL Scan

Press **【3】** in main menu for “WL Scan” test (Fig 41). **【ESC/STOP】** to exit.

To load a previous curve, press **【LOAD】** and select a previously stored curve (.wav)

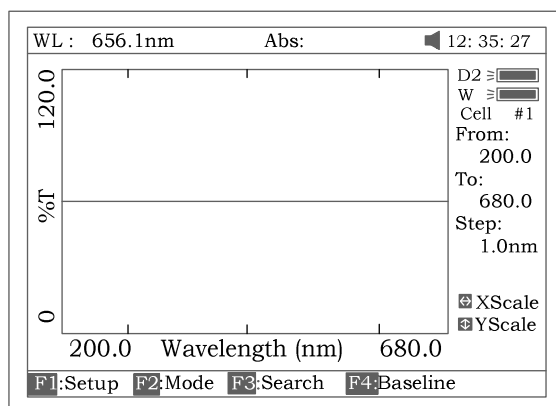

Fig 41

☺ Scan sample

1. Press **【F1】** to setup, input the start wavelength, and end wavelength by pressing the numeric keypad (Fig 42). Note: This instrument scans from high to low wavelength. Browse and select the items of scan step and scan speed by pressing **【^】** or **【v】**.

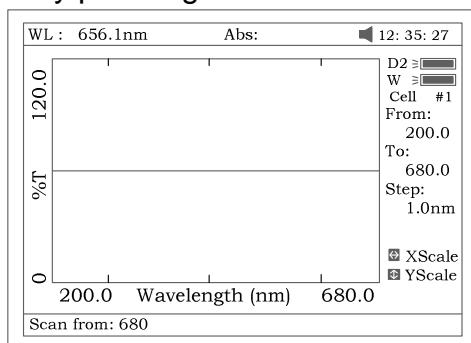

Fig 42

Note: "Scan step" allows the selection of 0.1nm, 0.2nm, 0.5nm, 1nm, 2nm and 5nm. "Scan speed" allows the selection of "HI", "MEDIUM" and "LOW". For survey scan we suggest 5nm, HI. For detailed scan we suggest 0.5nm, HI

2. Press **【F2】** to select the test mode, "Abs", "%T" or "E" (Fig 43).

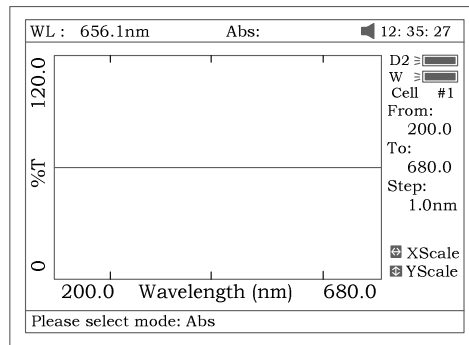

Fig 43

3. Put the blank cuvette into the Light Path, press **【ZERO】** to scan the base line (Fig 44). Press the key **【ESC/STOP】** to stop scanning;

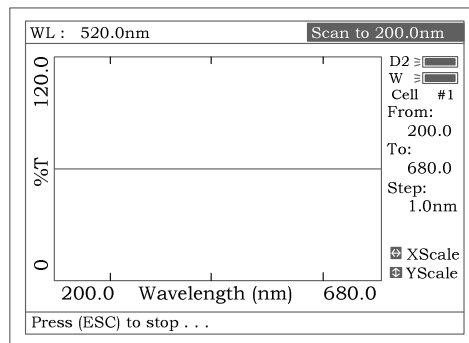

Fig 44

4. Put the sample cuvette into Light Path, press **【START】** to scan the sample (Fig 45) **【ESC/STOP】** to stop scanning. When scan has finished the beeper beeps 3 times (Fig 46).

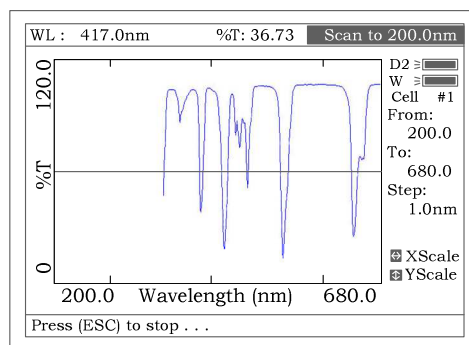

Fig 45

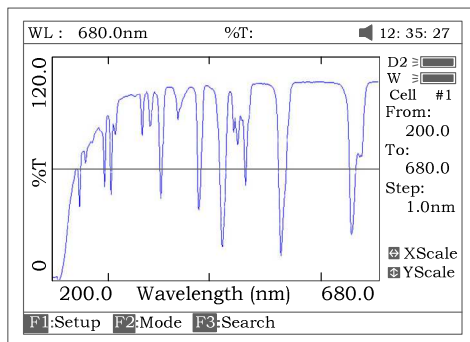

Fig 46

5. If you want to change the scale, press **<** or **>** to change “x” scale (Fig 47), input upper limit and lower limit by pressing the numeric keypad . To change “y” scale press **^** or **v** . After these inputs the instrument will redraw the curve (Fig 48).

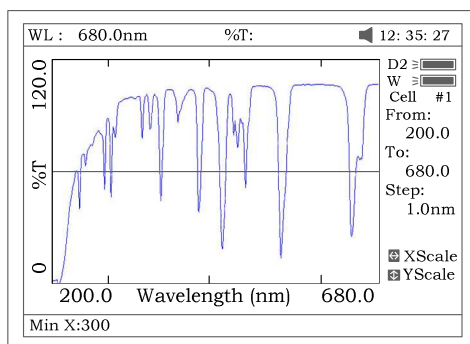

Fig47

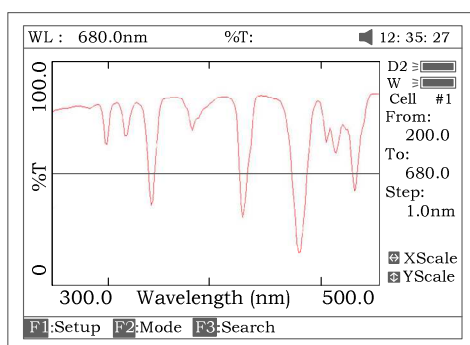

Fig 48

6. Press **F3** to search the Abs/%T value of the scan. There are two ways for you to search (Fig 49).

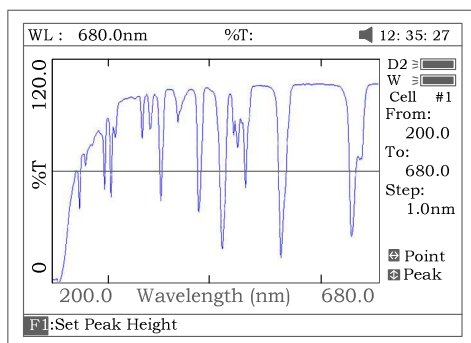

Fig 49

- 1) **Peak to peak**, press **[F1]** to set “peak height” and input value by pressing the numeric keypad (Fig 50). Press **[^]** to search the peak from left to right and press **[v]** to search from right to left. The value of every peak found will be displayed on the screen one at a time (Fig 51).

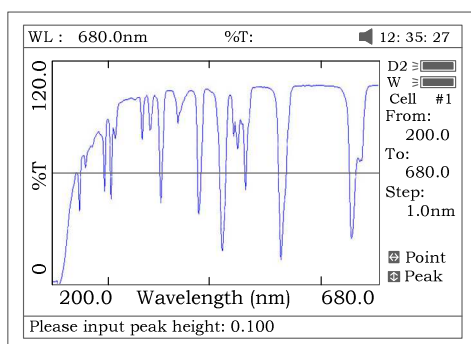

Fig 50

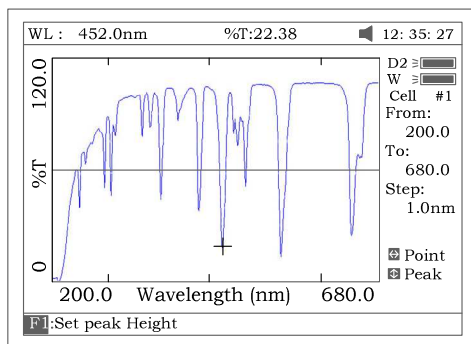

Fig 51

- 2) **Point to point**, Press **[>]** to search the point from left to right and press **[<]** to search from right to left. The search step interval is the same as the scan step. The value of every point searched will be displayed on the screen.

☺ **Save Curve**

Press **[SAVE]** to save the curve. Note: Load/Save requires the first scan display page (Fig. 48). Press **ESC** if in Search to return to the required page

☺ **Print Test Report**

Press **【PRINT】** to print the curve you have loaded or scanned (Fig 52).

Note: The report always is printed in Fig 46

Wavelength Scan Test Report

File Name:
Date and Time: 25-06-2003 13:47:54
Scan From: 680.0nm
Scan To: 200.0nm
Scan Step: 1.0nm
Peak Height: 0.030Abs

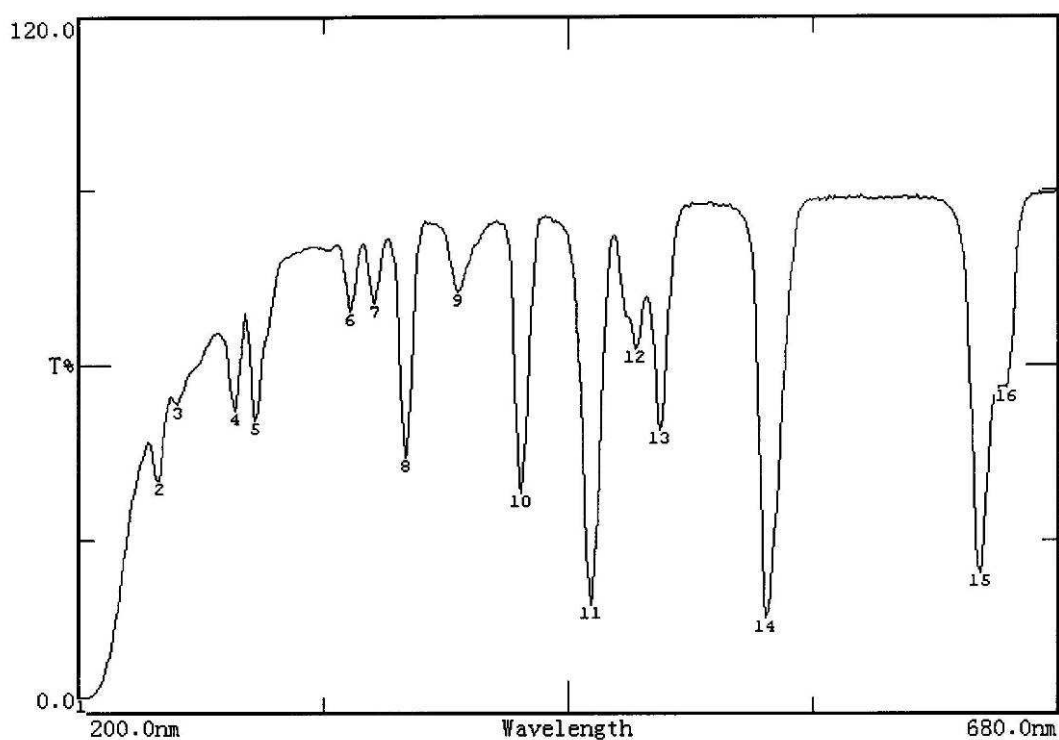

Peak list:

No.	Wavelength(nm)	Abs	T%
1	202.0	1.585	2.60
2	240.0	0.397	40.08
3	249.0	0.274	53.18
4	277.0	0.285	51.93
5	287.0	0.298	50.30
6	333.0	0.161	68.98
7	345.0	0.154	70.19
8	360.0	0.357	43.95
9	386.0	0.141	72.26
10	417.0	0.422	37.83
11	451.0	0.731	18.58
12	473.0	0.205	62.38
13	485.0	0.313	48.61
14	537.0	0.790	16.22
15	641.0	0.621	23.95
16	654.0	0.252	55.93

Fig 52

Kinetics

Press **【4】** in main menu for “Kinetics” (Fig 53). **【ESC/STOP】** to exit. To load a previous kinetics result, press **【LOAD】** and select a previously stored result (.kin)

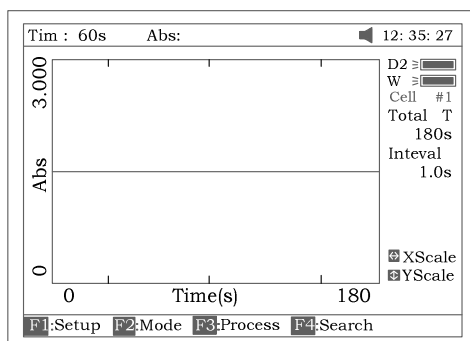

Fig 53

☺ Test

1. Press **【F1】** to set “Total Time”, ”Delay Time”, ”Time interval”, and input the value by pressing the numeric keypad (Fig 54).

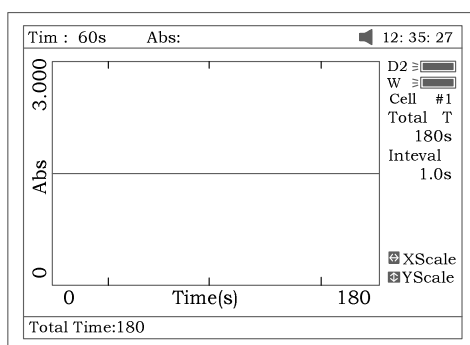

Fig 54

2. Select the test mode (“Abs” or “%T”) by pressing **【F2】** (Fig 55).

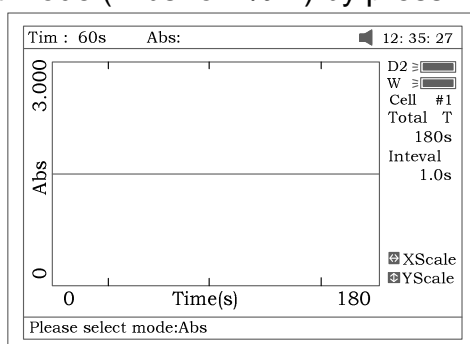

Fig 55

3. Set wavelength by pressing **【SET λ 】**. Pull the blank cuvette into the Light Path, press **【ZERO】** for blanking
4. Pull the sample cuvette into Light Path, press **【START】** to scan the sample. After the delay time, the beeper beeps 3 times and time -scan starts. At the end of the time-scan, the beeper also beeps 3 times (Fig

56);

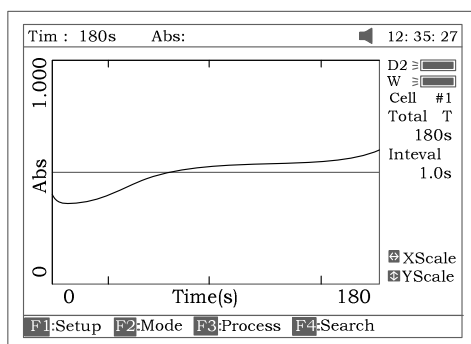

Fig 56

5. Press **[F3]** to process the data, and enter "Begin Time", "End Time" and "Factor" (Fig 57) and the value in I.U. will be calculated and displayed (Fig 58). The average straight line between the Begin Time and End Time will be calculated. The gradient of this line gives the rate of change of $\Delta A/\text{min}$.

Note: $\text{I.U.} = \text{Factor} \times \Delta A/\text{min}$

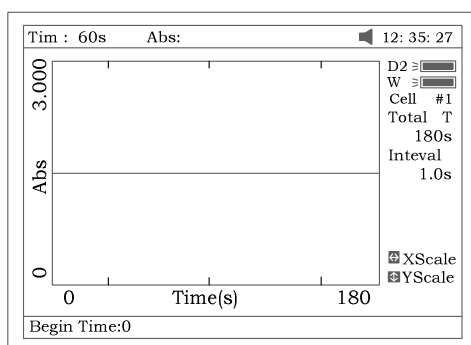

Fig 57

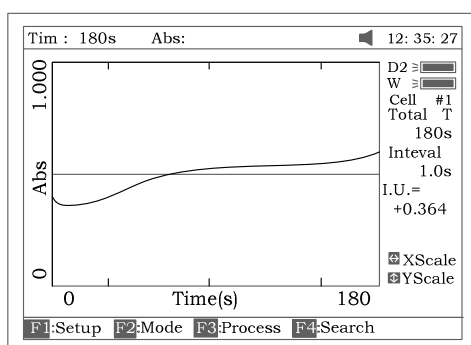

Fig 58

6. If you want to change the scale, please refer to step 5 of "WL scan".
7. Press **[F4]** to search the Abs/%T value in relation to the time axis. Search point to point by pressing the key **[<]** or **[>]**. Please refer

to step 6 of "WL scan".

☺ **Save Curve**

Press the key **【SAVE】** to save curve. Note: Load/Save requires the first kinetics display page Fig. 56. Press **ESC** if in Search to return to the required page.

☺ **Print Test Report**

Press the key **【PRINT】** to print the curve you have loaded or scanned (Fig 59).

```
                Kinetics Test Report

File Name:      Q1.kin
Date and Time:  26-06-2003 08:20:11
Total Time:     180s
Time Interval:  1.0s
I.U.:          +0.000    From 0s to 1s
```

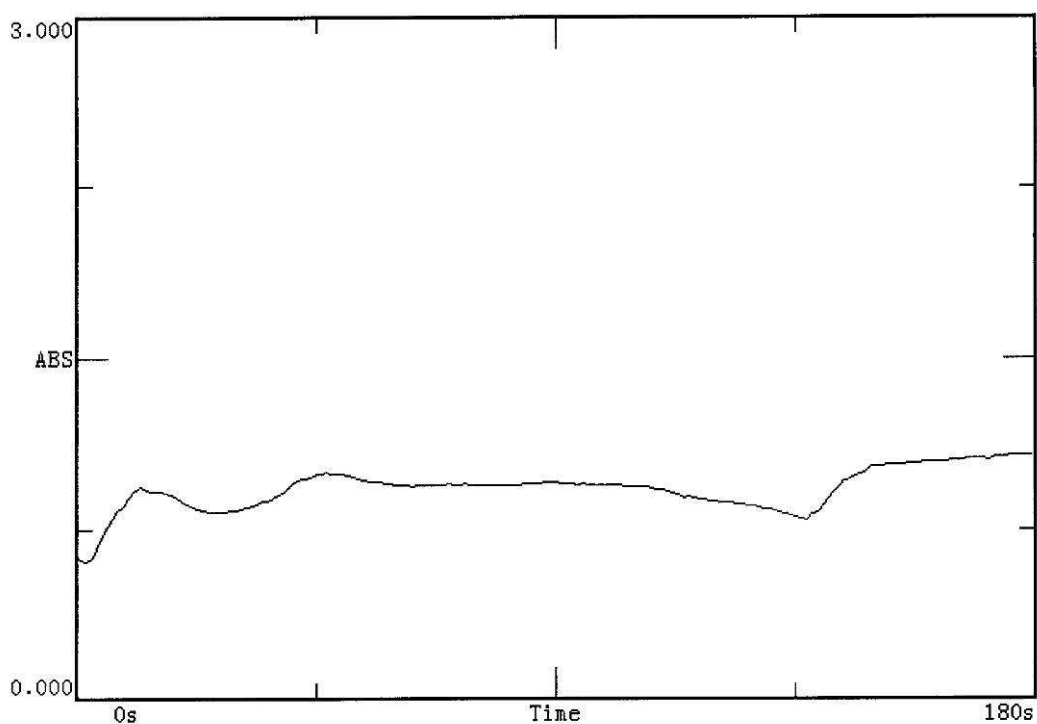

Fig 59

DNA/Protein

Press **[5]** in main menu for “DNA/Protein” (Fig 60). **[ESC/STOP]** to exit.

Note: The algorithm of the test refer to Appendix A please.

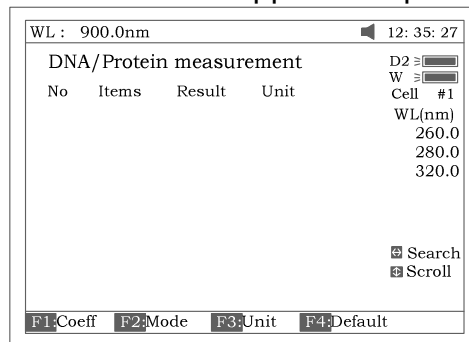

Fig 60

To load previous DNA results, press **(LOAD)** and select a previously stored result (.dna)

☺ Test

1. To use a simpler or different algorithm, you can enter your own values for f1-f4. Press **[F1]** to set f1-f4. Input the value by pressing the numeric keypad (Fig 61).

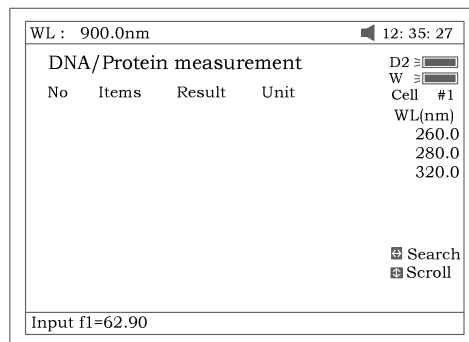

Fig 61

2. Press **[F2]** to select test mode. "Absorbance difference 1" is for testing at the wavelength 260nm, 280nm and 320nm (optional), and the "Absorbance difference 2" is for testing at the wavelength 260nm, 280nm and 320nm (optional, Fig 62). Then select with/without reference. If selected with reference (no), the A ref. will be "0" (Fig 63).

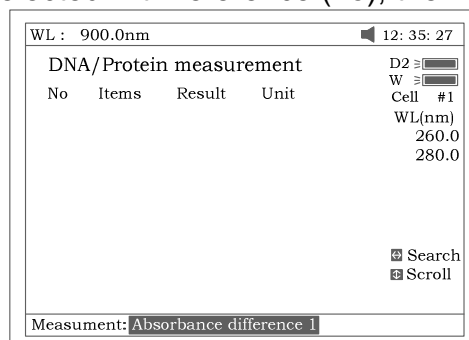

Fig 62

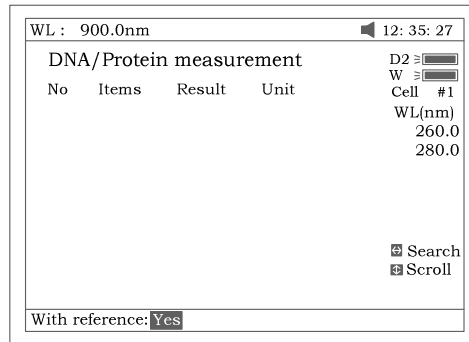

Fig 63

3. Press **【F3】** to select the unit of concentration (Fig 64).

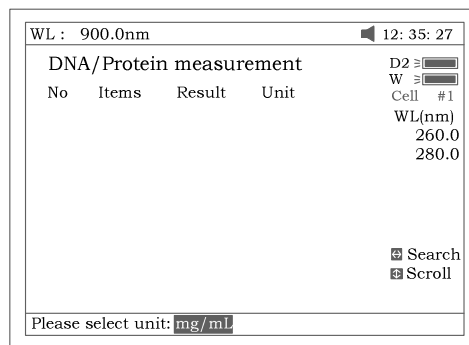

Fig 64

4. Push the blank cuvette into the Light Path, then press **【ZERO】** for blanking .
5. Pull the sample cuvette into Light Path, press **【START】** to test the sample. The test result will be displayed on the screen (Fig 65).

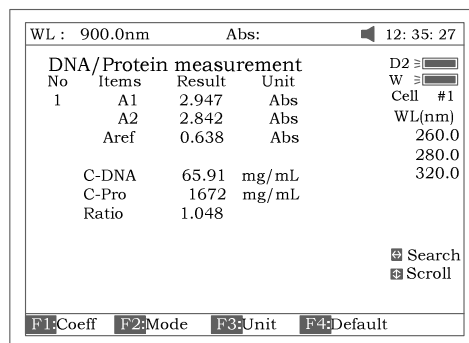

Fig 65

6. If there is more than one sample, repeat step 5 for the next sample.
7. Press the key **【<】** or **【>】** for searching. Input the sample number (Fig 66), the result will be displayed on the screen. Press the key **【^】** or **【v】** to browse the test results one by one.

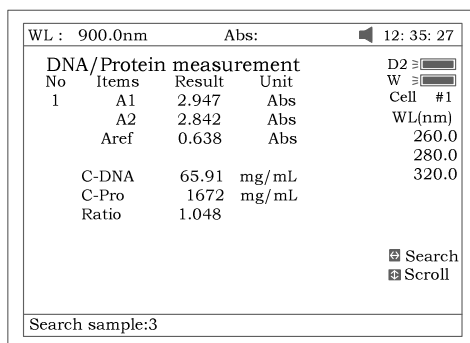

Fig 66

☺ **Recall the default**

Press the key **【F4】** to recall the default of the f1-f4.

☺ **Save Data**

Press the key **【SAVE】** to save data.

☺ **Print Test Report**

Press the key **【PRINT】** to print the test result (Fig 67).

DNA / Protein Test Report

File Name:

Date and Time: 26-06-2003 09:16:33

No	260.0nm	280.0nm	320.0nm	C-DNA	C-Pro	Ratio
1	0.226	0.212	0.102	3.825	76.60	1.127
2	0.226	0.213	0.102	3.803	79.32	1.113

Unit:ug/mL

Fig 67

Multi Wavelength

Press **【6】** in main menu for "Multi WL" (Fig 68). **【ESC/STOP】** to exit.

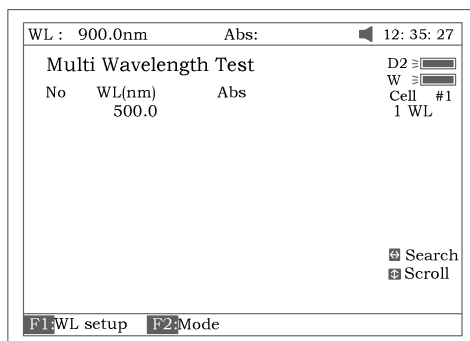

Fig 68

To load previous Multi Wavelength results, press **(LOAD)** and select previously stored results (.mul)

☺ **Test**

1. Press **【F1】** to setup a group of wavelengths for testing by pressing the numeric keypad followed by **【ENTER】**. (**^**) or (**v**) to modify the inputted data Fig. 69. Press **【ESC/STOP】** to finish setup and exit.
Note: It is recommended to enter the highest wavelength first.

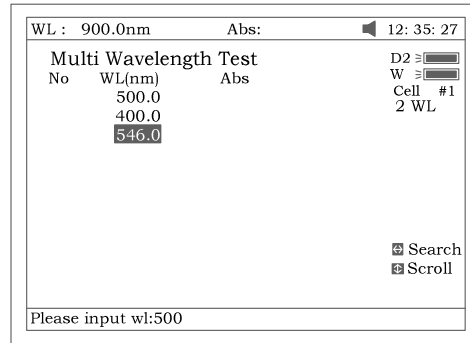

Fig 69

2. Press **【F2】** to select mode (Fig 70).

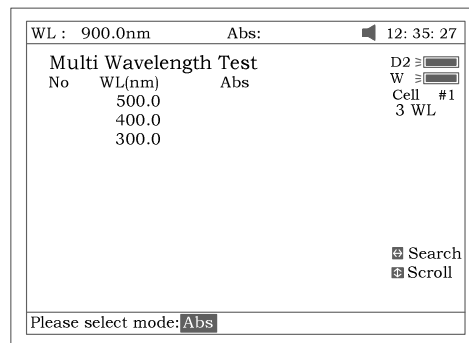

Fig70

3. Push the blank cuvette into the Light Path, then press **【ZERO】** for Blanking .
4. Pull the sample cuvette into Light Path, press **【START】** to test. The test results will be displayed on the screen (Fig 71).

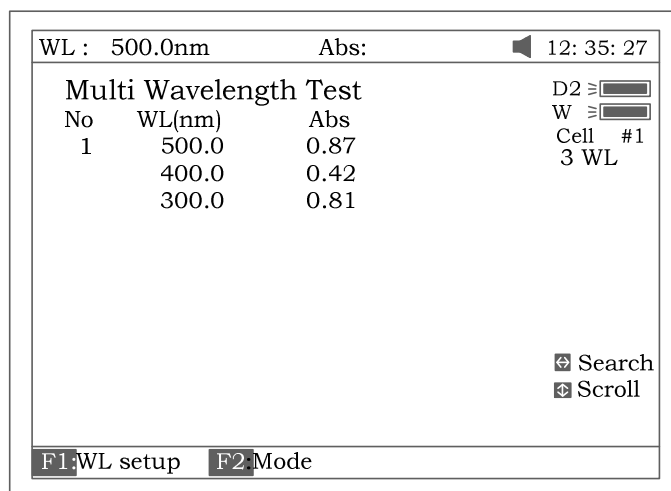

Fig 71

- If there is more than one sample, repeat step 4 for the next sample.
Note: When the test has finished, the wavelength will go to the first WL.
- Press **<** or **>** for searching. Input the sample number, the result will be displayed on the screen. Press **^** or **v** to browse the test results one by one.

☺ **Save Data**

Press **SAVE** to save data.

☺ **Print Test Report**

Press **PRINT** to print the test results (Fig 72).

Multi-Wavelength Test Report

File Name: M1.mul
Date and Time: 26-06-2003 09:25:16

No	300.0nm	400.0nm	500.0nm
1	0.107	0.074	0.054
2	0.106	0.073	0.055
3	0.106	0.072	0.054

Unit:Abs

Fig 72

Setting and Calibration Utility

Press **【7】** in Main menu for “Utility” (Fig 73). **【ESC/STOP】** to exit.

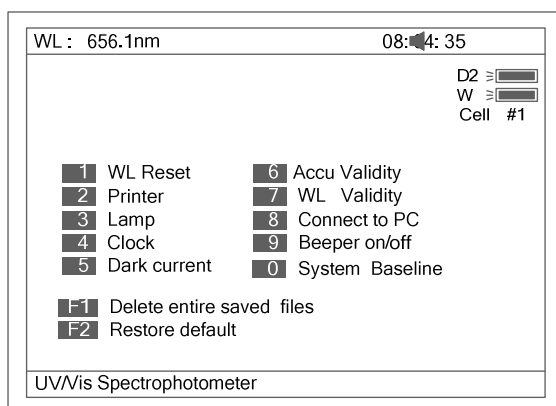

Fig 73

☺ WL Reset

Press **【1】** to reset wavelength (Fig74).

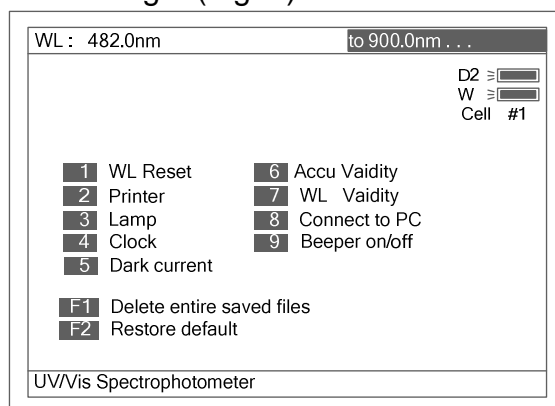

Fig 74

☺ Printer

Press **【2】** to set printer (Fig 75). **【ESC/STOP】** to exit.

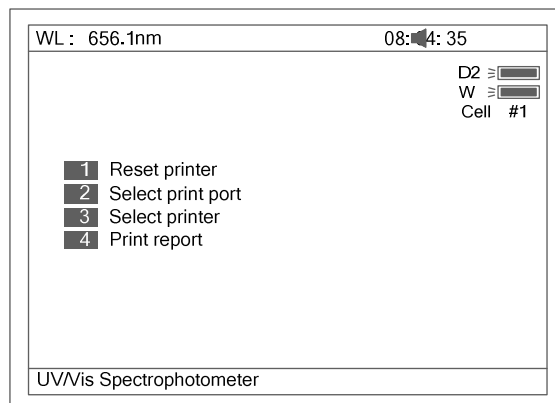

Fig 75

1. Press **【1】** in Fig 75 to Reset Printer.
2. Press **【2】** in Fig 75 to select print port (LPT or Comm., Fig 76).

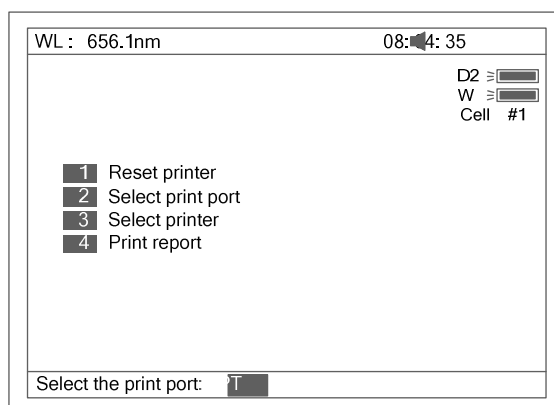

Fig 76

3. Press **【3】** in Fig 75 to select printer (HP PCL (1 colour cartridge), PCL (black mode), Epson ESC/P or Epson/P2 or above, Fig77).

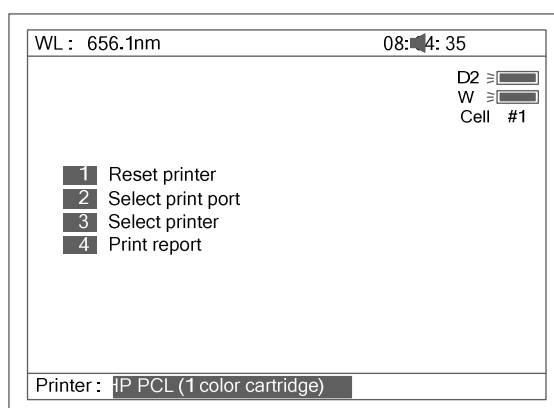

Fig 77

4. Press **【4】** in Fig 75 to select print mode. If you select "Print screen" mode, a little icon will be displayed on the top line of the screen (Fig 78), if you select "Print report" mode, the little icon will disappear.

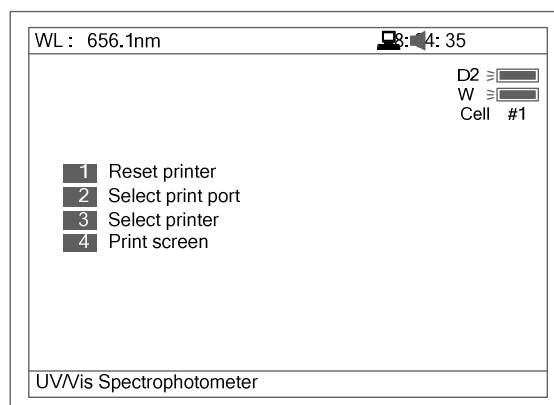

Fig78

☺ Lamp

Press **【3】** to set lamp (Fig 79). **【ESC/STOP】** to exit.

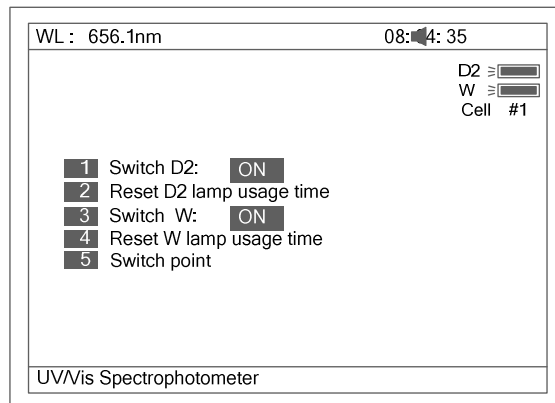

Fig 79

1. Press **【1】** in Fig 79 to switch on/off D2. Fig 80.

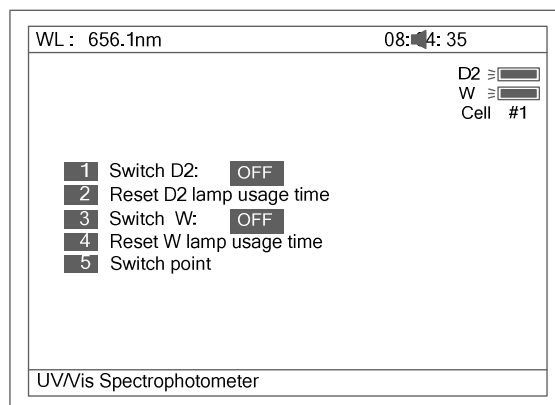

Fig 80

2. Press **【2】** in Fig 79 to reset usage time of D2 (Fig 81). Press **【^】** or **【V】** to select "Yes" or "No", and then press **【ENTER】**.

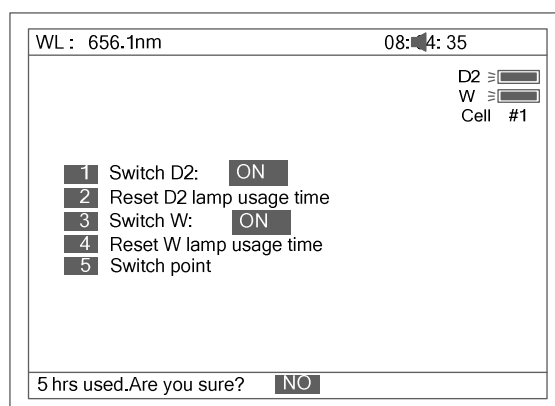

Fig 81

3. Press **【3】** in Fig 79 to switch on/off W. The indication is also on the top

right corner of the screen (Fig 82).

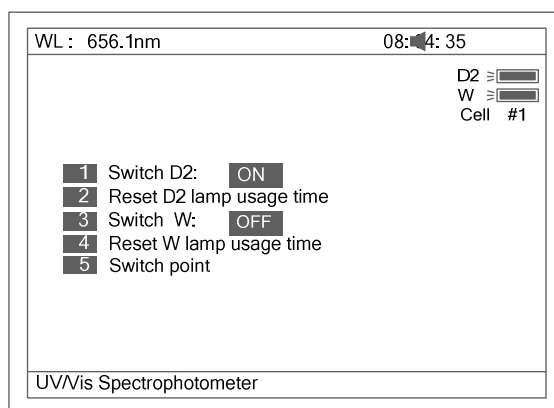

Fig 82

4. Press **【4】** in Fig 79 to reset usage of W (Fig 83). Press **【^】** or **【V】** to select “Yes” or “No”, and then press **【ENTER】** .

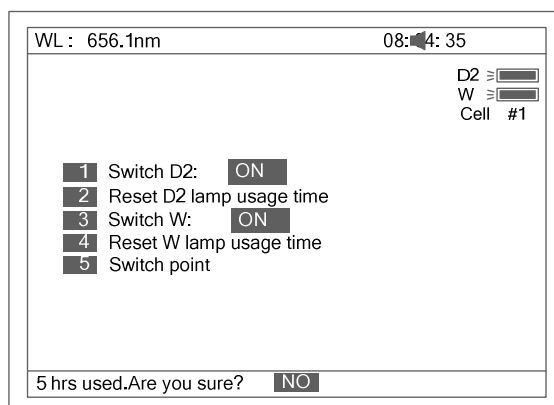
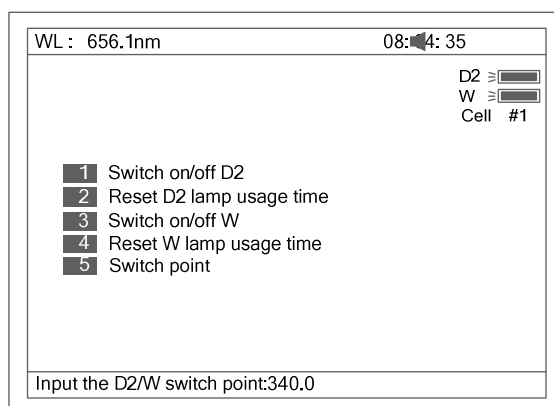

Fig 83

5. Press **【5】** in Fig 79 to set the switch usage point of D2 and W lamp (Fig 84).



84

☺ Clock

Press **【4】** In Fig73 to set the display mode and modify the clock (Fig 85).

【ESC/STOP】 to exit.

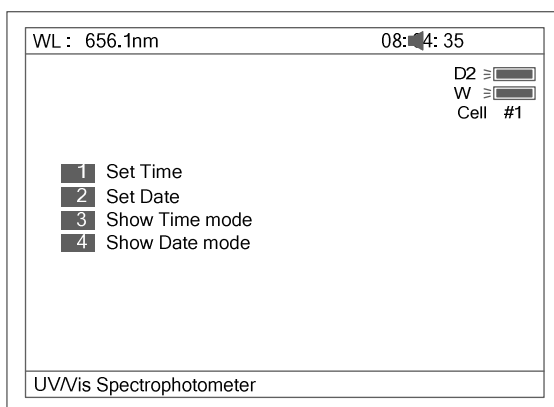

Fig 85

1. Press **【1】** in Fig 85 to modify time by pressing the numeric keypad (Fig 86).

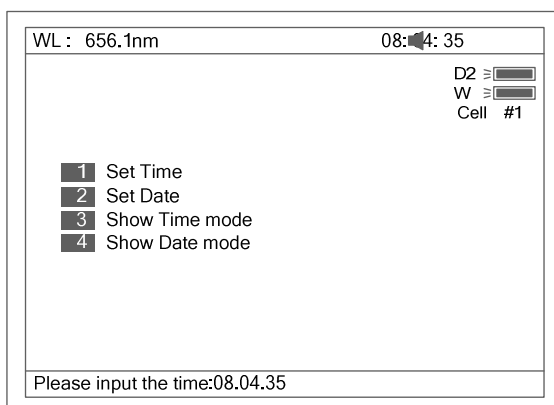

Fig 86

2. Press **【2】** in Fig 85 to modify date by pressing the numeric keypad.
3. Press **【3】** in Fig 85 to set the date display on the top right corner of the screen.
4. Press **【4】** in Fig 85 to set the time display on the top right corner of the screen (Fig 87).

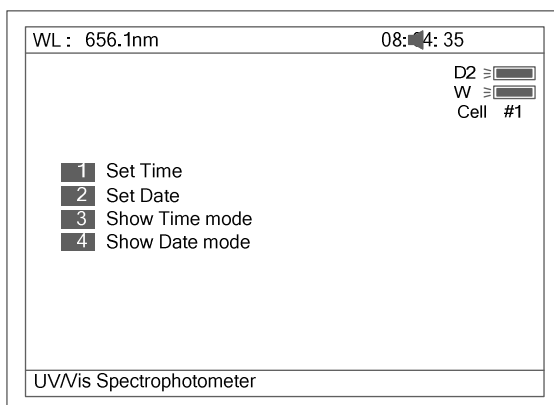

Fig 87

☺ **Dark Current**

Press **【5】** In Fig73 to get dark current (Fig 88).

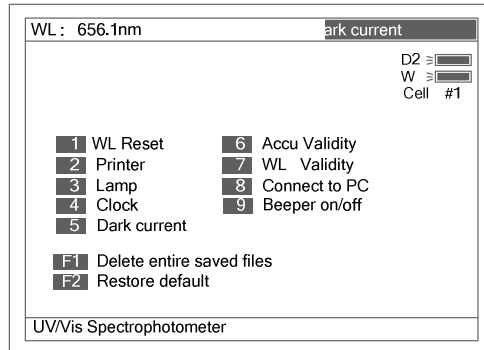

Fig 88

☺ **Accu Validity**

Press **【4】** In Fig73 to do Accu Validity (Fig 89). **【ESC/STOP】** to exit.

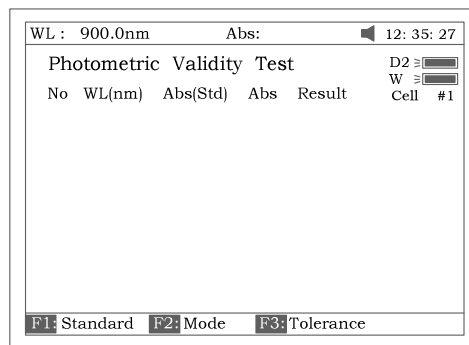

Fig 89

1. Press **【SET λ】** to set the wavelength. Press **【ENTER】** to edit and input wavelength by pressing the numeric keypad (Fig 90). **【ESC/STOP】** to finish inputting and exit.

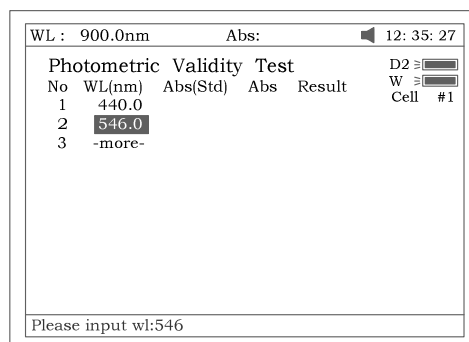

Fig 90

2. Press **【F1】** to set the standard value, Press **【ENTER】** to edit and input by pressing the numeric keypad (Fig 91). **【ESC/STOP】** to finish inputting and exit.

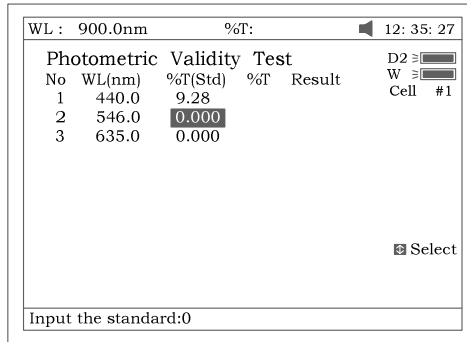

Fig 91

3. Press **【F2】** to select test mode (Abs or %T, Fig 92).

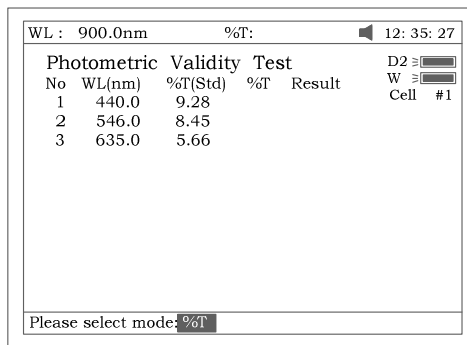

Fig 92

4. Press **【F3】** to set tolerance (Fig 93). Input the value by pressing the numeric keypad.

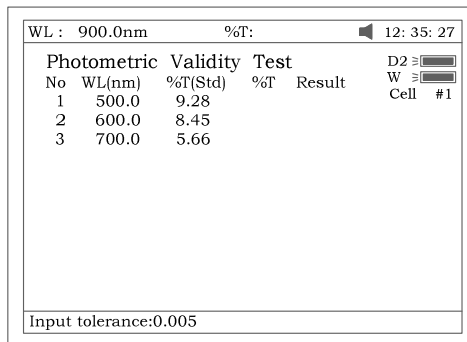

Fig 93

5. Press **【ZERO】** for Blanking.
6. Put the sample (calibrated neutral density filter) into Light Path. Press **【START】** to check. The results will be displayed on the screen (Fig 94). If the discrepancy between the results and the calibrated standards is not more than the tolerance, "pass" will be displayed after the test result. Otherwise, "fail" will be displayed.
7. The result can be saved, loaded and printed by pressing **【SAVE】**, **【LOAD】** and **【PRINT】**.

WL : 900.0nm		%T:		12: 35: 27	
No	WL(nm)	%T(Std)	%T	Result	
1	500.0	9.28	9.28	pass	
2	600.0	8.45	8.45	pass	
3	700.0	5.66			

F1: Standard F2: Mode F3: Tolerance

Fig 94

☺ **WL Validity**

Press **【7】** in Fig 73 to WL validity (Fig 95). **【ESC/STOP】** to exit.

WL : 900.0nm		Abs:		12: 35: 27	
No	WL(nm)	Peak(nm)	T%	Result	

F1: Set peaks F2: Mode F3: Tolerance

Fig 95

1. Press **【F1】** to set the standard peak. Press **【ENTER】** to edit and input wavelength by pressing the numeric keypad (Fig96). **【ESC/STOP】** to finish inputting and exit.

WL : 900.0nm		%T:		12: 35: 27	
No	WL(nm)	Peak(nm)	%T	Result	
1	241.4				
2	361.0				
3	417.0				
4	537.6				
5	641.4				
6	807.4				

Select

Input the standard:0

Fig 96

2. Press **【F2】** to select test mode (Abs or %T, Fig 97).

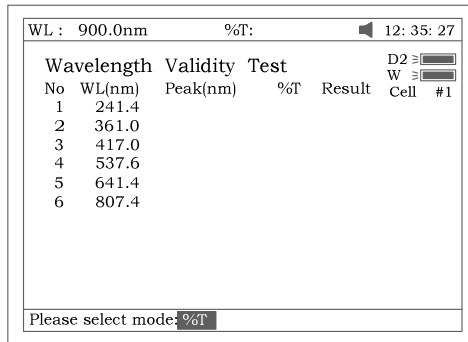

Fig 97

3. Press **【F3】** to set tolerance (Fig 98). Input the value by pressing the numeric keypad.

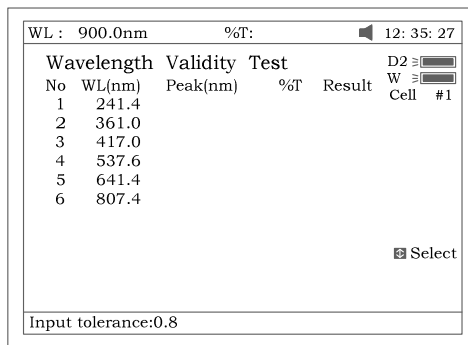

Fig 98

4. Press **【ZERO】** for blanking.
5. Put the sample (calibrated holmium liquid) into Main Light Path. Press **【START】** to check. The results will be displayed on the screen (Fig 99). If the discrepancy between the results and the calibrated values is not more than the tolerance, "pass" will be displayed after the test results. Otherwise, "fail" will be displayed.

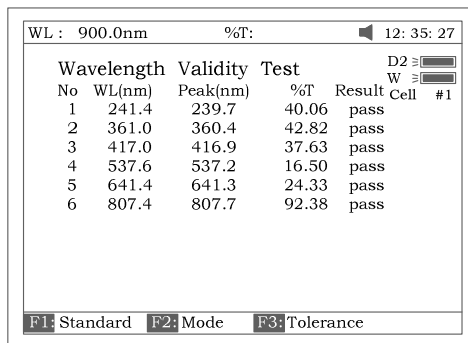

Fig 99

6. The result can be saved, loaded and printed by pressing **【SAVE】**, **【LOAD】** and **【PRINT】**

☺ Connect to PC

Press **【8】** in Fig 73 to connect to PC (Fig 100). If the instrument is controlled

by PC, the screen displays as Fig 100A. Press **【ESC/STOP】** to exit.

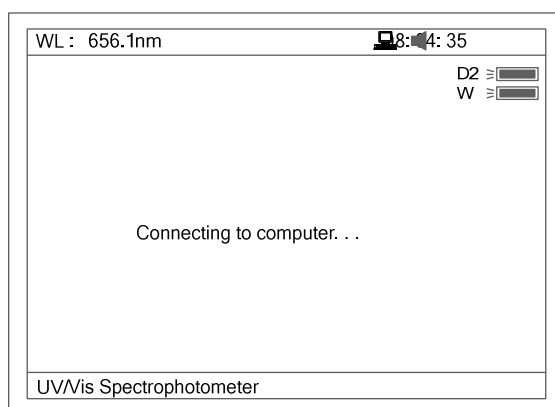

Fig 100

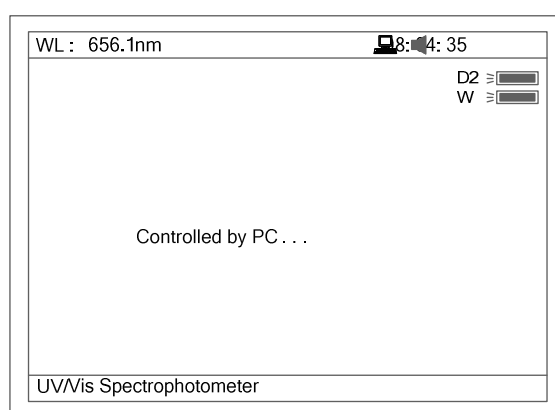

Fig 100A

☺ **Beeper on/off**

Press **【9】** in Fig 73 to turn on/off the beeper

☺ **Delete entire saved files**

Press **【F1】** in Fig 73 to delete entire saved files. After the delete the files, double confirm need to do.

☺ **Restore default**

Press **【F2】** in Fig 73 to restore the default parameters.

Instrument Maintenance

To keep the instrument work in good condition, constant maintenance is needed.

Daily Maintenance

1, Check the compartment

After measurement, the cuvettes with sample solutions should be taken out of the compartment in time. Or the volatilization of the solution would make the mirror go moldy. Users must pay more attention to the corrosive samples and liquid easy to volatilize. Any solution remains in the compartment should be wiped off immediately.

2, Surface Clean

The cover of the instrument is with paint. Please use wet towel to wipe off the drips on the surface immediately. Organic solution is forbidden to be used to clean the cover. Please wipe off the dirt on the cover timely.

3, Clean the cuvettes

After every test or after a solution change, the cuvettes should be cleaned carefully, or the remains on the surface would cause measuring error.

Troubleshooting

1, No response after power on

Possible Cause

- Bad contact in power supply
- Fuse melt

Solution

Improve the contact
Replace a new fuse

2, No Stable Reading

Possible Cause

- No enough pre-warm
- Glass cuvettes used in UV Range
- unstable Sample
- Much higher sample concentration
- Low voltage or unstable power supply
- Lights defect
- Light used up

Solution

Increase the pre-warm time
Use Silicon Cuvettes in UV Range
Improve the sample
Dilute the sample
Improve the power condition
Replace a new lamp
Replace a new lamp

3, Worse Repeatability

Possible Reason

- Unstable sample
- Cuvettes polluted

Solution

Improve the sample
Clean the cuvettes

Spare parts replacement

1, Replace the Fuse



Danger! Be sure to switch off the power and unplug the socket before replacement!

Step 1: Tools preparation

Prepare a 3x75mm Flat Blade Screwdriver

Step 2: Switch Off the power supply

Switch off the power supply, and unplug the socket.

Step 3: Take out the Fuse Seat

Take out the Fuse Seat by the Screwdriver. (Fig 101)

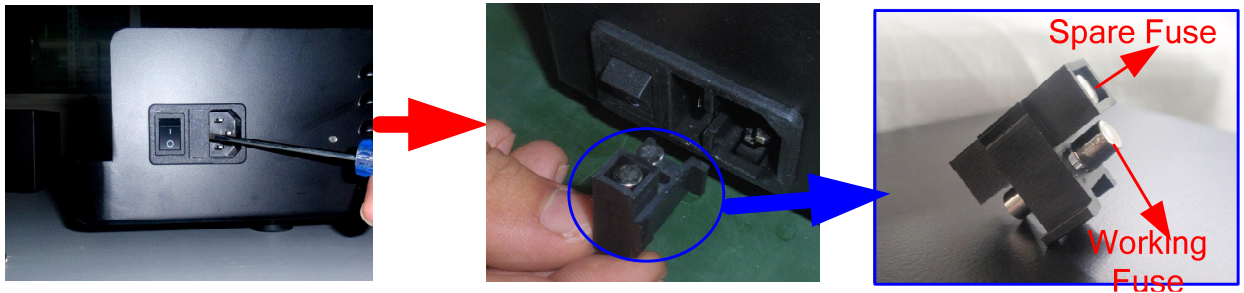

Fig 101

Step 4: Replace a new Fuse

Pick out the Spare Fuse and replace it to the working position.

Step 5: Reset the Fuse Seat

Replace the Fuse Seat in the power socket

Step 6: Switch on the power

Plug the socket and switch on the power

2, Replace lamps



High temperature! Wait 20 minutes before open the lamp chamber after power off to avoid scald!

Step 1 Tools preparation

Prepare a 6x150mm Cross Blade screwdriver and a pair of glove.

Step 2 Switch Off the power supply

Switch off the power supply and unplug the socket.

Step 3 Remove the cover

Unscrew the 4 screws indicated in Fig.102 (Each side with 2 screws), then remove the cover to one side.



Fig 102

Step 4: Remove the cover of the Lamp Chamber

Step 5: Replace Lamps

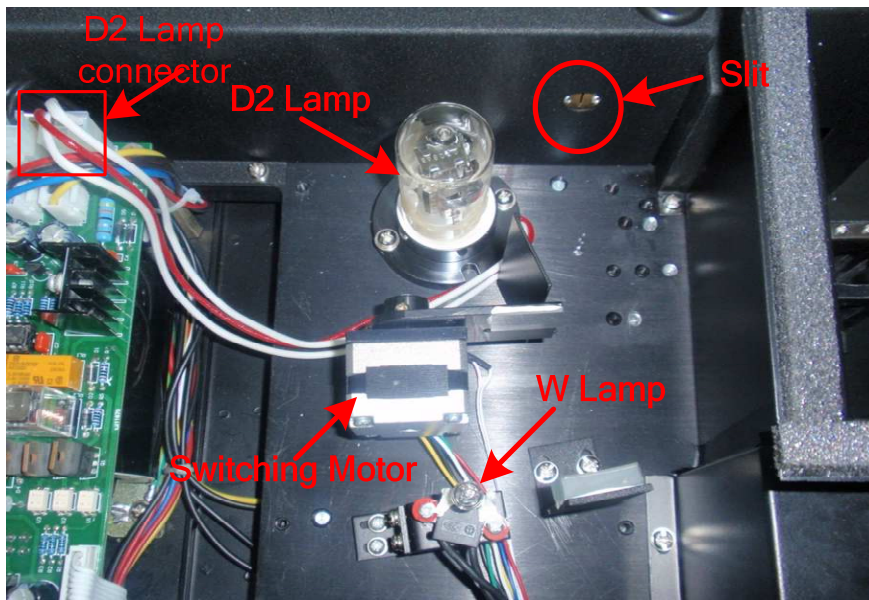

Fig 104 Top View of Lamp Chamber

1) Replace D2 Lamp

Unscrew the 2 screws on the D2 Flange (Indicated in the Red Circles in Fig 105), unplug the power connector (Indicated in the Red Square in Fig.104) in the Power Board and remove the D2 lamp. Draw on the Cotton Glove and replace a new lamp. Fix the 2 screws and plug the connector again.

The D2 Lamp is pre-aligned, so there's no need to re-adjust the position of it. The Facula should focus on the center of the Slit.

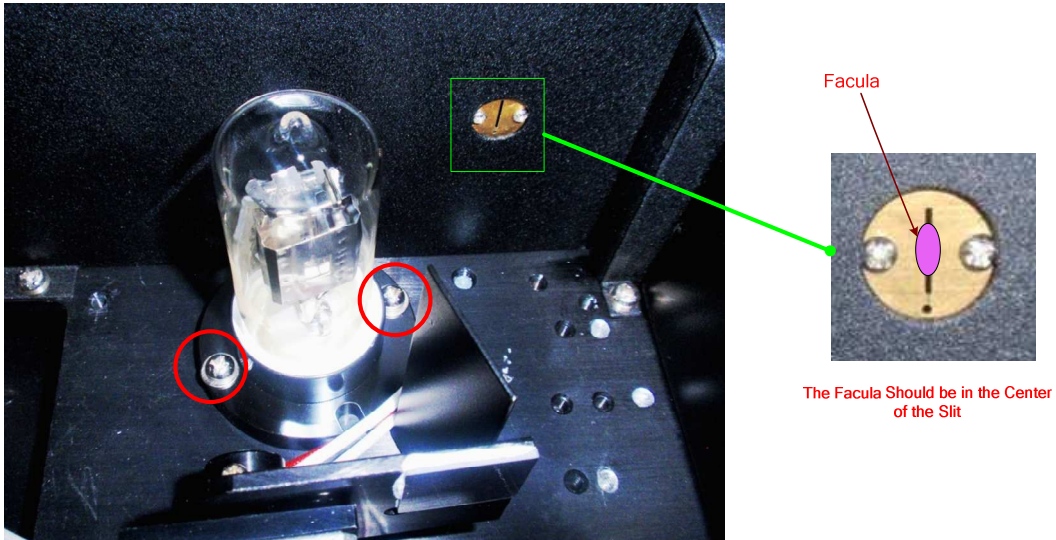

Fig. 105

2) Replace W lamp



Remember the direction of the filament before pull out the W lamp. Be sure that the new lamp's filament is in the same direction as before.

Pull out the defected W lamp and draw on the Cotton Glove. Insert the new W lamp as deep as possible on the Lamp Seat. Be sure to keep the Filament in the same direction as the old one faces (Fig.106)

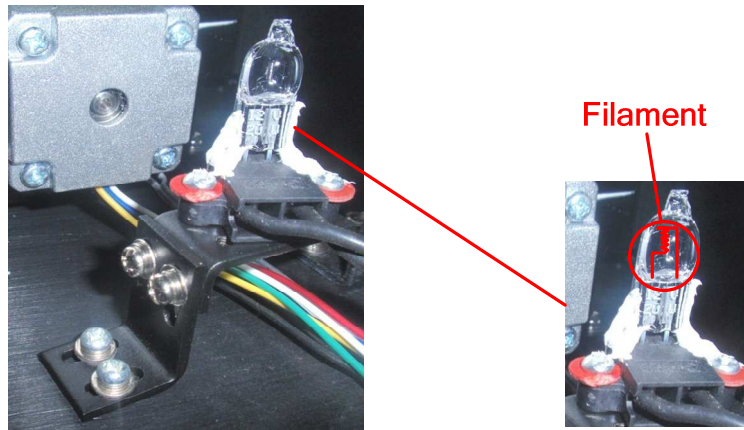
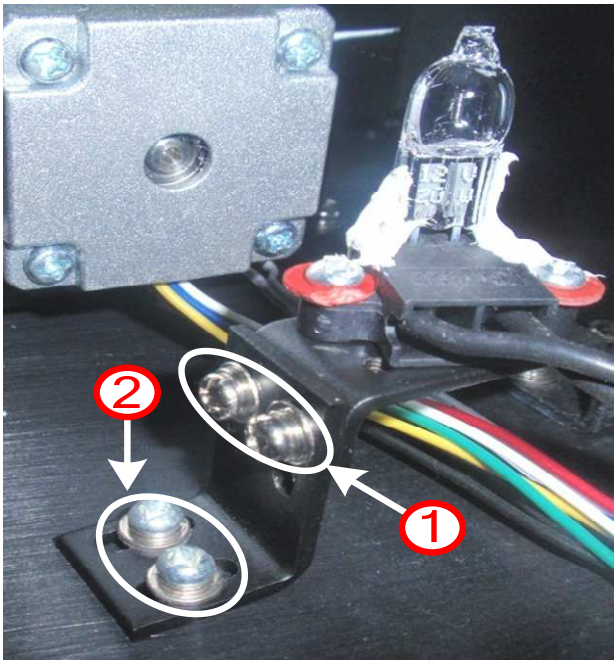

Fig. 106

Switch on the power, observe the Entrance Facula, and it should focus on the center of the Slit. (Fig.107)

If the Facula deviate to Left or Right, then loosen the No.2 screws in Fig.107 and move the lamp seat to Left or Right until it focus on the center of the slot. Then fix the screws.

If the facula deviate to Up and Down, then loosen the No.1 screws in Fig.107 and move the lamp seat Up and Down until the facula focus on the center of the slit. Then fix the No. 1 screws again.



The Facula should focus on the center of the Slit

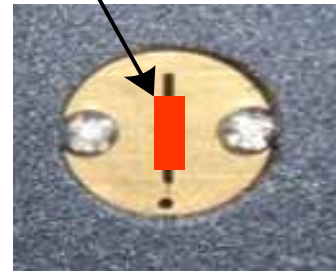

Fig.107

Step 8 Finish

Reset the cover of the Lamps chamber and fix the screws.
Reset the cover of the instrument and fix the screws.
then the course finished.

Appendix A

DNA/Protein Test Algorithm

Test Name	Method	Wavelength(s)	Calculations	Parameters	Displayed Units
DNA MEASUREMENT					
DNA/Protein Concentration and DNA purity	Absorbance difference (260,280)	$A_1=A_{260nm}$ $A_2=A_{280nm}$ $A_{ref}=A_{320nm}$ (optional)	DNA concentration: $(A_1-A_{ref})f_1-(A_2-A_{ref})f_2$ Protein concentration $(A_2-A_{ref})f_3-(A_1-A_{ref})f_4$	$f_1=62.9$ $f_2=36.0$ $f_3=1552$ $f_4=757.3$	DNA: μ g/ml Protein: μ g/ml
	Absorbance difference (260,230)	$A_1=A_{260nm}$ $A_2=A_{230nm}$ $A_{ref}=A_{320nm}$ (optional)	DNA concentration: $(A_1-A_{ref})f_1-(A_2-A_{ref})f_2$ Protein concentration $(A_2-A_{ref})f_3-(A_1-A_{ref})f_4$	$f_1=49.1$ $f_2=3.48$ $f_3=183$ $f_4=75.8$	
	Absorbance ratio	$A_1=A_{260nm}$ $A_2=A_{280nm}$ or A_{230nm} $A_{ref}=A_{320nm}$ (optional)	Ratio= $\frac{A_1-A_{ref}}{A_2-A_{ref}}$	None	No units(ratio)

Appendix B

A number of correction techniques can be used to eliminate or reduce interference errors. In general, if the source of the error is known and is consistent from sample to sample, the error can be eliminated. On the other hand, if the source is unknown and varies from sample to sample, the error can be reduced but not eliminated. Correction techniques can always require data from at least two wavelengths. The more sophisticated correction techniques require multiwavelength or spectral data.

A.1 Isoabsorbance

When a known interfering component with a known spectrum is present, the error introduced by this component at the analytical wavelength for the target analyte can be eliminated by selecting a reference wavelength at which the interfering compound exhibits the same absorbance as it does at the analytical wavelength. The absorbance at this reference wavelength is subtracted from the absorbance at the analytical wavelength, as shown in Figure A1. The residual absorbance is the true absorbance of the analyte.

This technique is less reliable when the spectra of the analyte and of the interferent are highly similar. Moreover, it can correct for only one interference

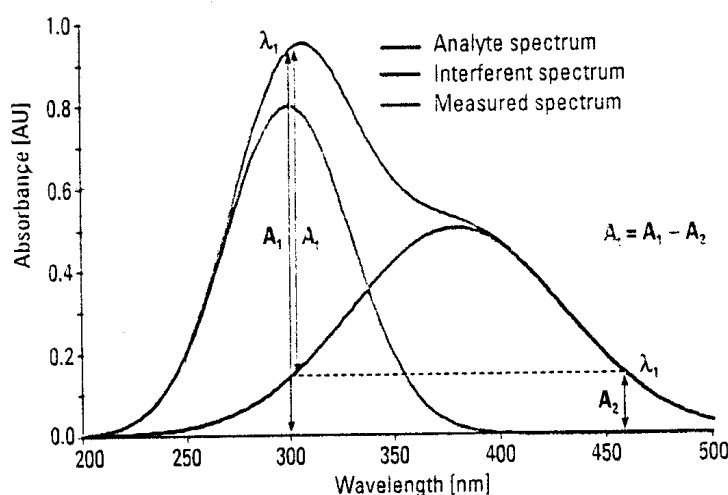

Fig A1 Isoabsorbance correction

A.2 Three-point correction

The three-point, or Morton-Stubbs correction uses two reference wavelengths, usually those on either side of the analytical wavelength. The background interfering absorbance at the analytical wavelength is then estimated using linear interpolation (see Figure A2). This method represents an improvement over the single-wavelength reference technique because it corrects for any background absorbance that exhibits a linear relationship to the wavelength. In many cases, if the wavelength range is narrow, it will be a reasonable correction for non-linear background absorbances such as that resulting from scattering of from a complex matrix.

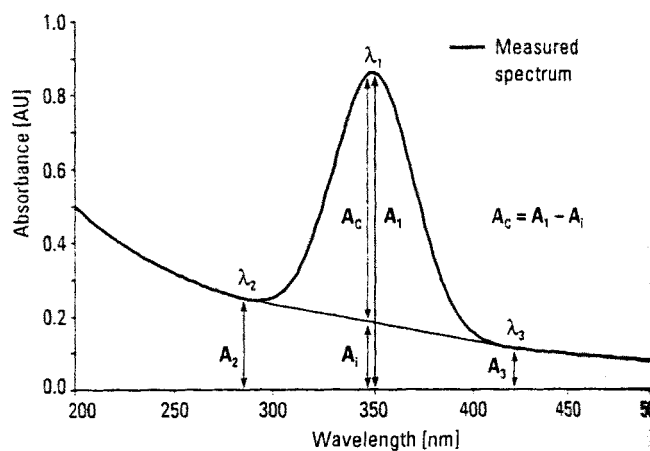

Fig A2